

SPAN

Remote Meter Kit

Installation Instructions



Product Specifications

All specifications and descriptions contained in this document are accurate at the time of publication. In the interest of product improvement, SPAN reserves the right to make product modifications at any time without advance notice.

For the latest SPAN product and installation documents, visit:
www.SPAN.io/partner-portal

For errors or omissions, contact support@SPAN.io
For complete product specifications and information on product listing and certification, refer to the Product Datasheet at www.SPAN.io.

SPAN assumes no liability for injury or property damage due to installation or service attempted by unqualified individuals, or due to a failure of installers or service technicians to properly follow safety, installation and service instructions.
© 2023 SPAN.IO, Inc. All rights reserved.

All information in this document is subject to copyright and other intellectual property rights of SPAN.IO, Inc. This material may not be modified, reproduced or copied, stored in a retrieval system, or transmitted, in whole or in part, without the prior written permission of SPAN.IO. Additional information is available upon request.

Trademarks

The following are trademarks or registered trademarks of SPAN in the United States and other countries.

SPAN, SPAN.IO, SPAN Panel

SPAN

All other trademarks in this document are the property of their respective owners, and their use within does not imply endorsement of their products or services. The unauthorized use of any trademark displayed in this document or on the product is strictly prohibited.

Electronic Device Waste Disposal

Proper disposal of electronic equipment is required. Refer to local codes for disposal requirements. To arrange for proper disposal of this product, contact your local authorities or dealer for proper disposal requirements.

Warranty

To secure the full product warranty, SPAN Remote Meter Kit must be registered by completing the commissioning process, which sends system information to SPAN. For complete warranty information, refer to the Product Warranty at www.span.io/warranty

Important Safety Instructions

SAVE THESE INSTRUCTIONS

Follow these instructions during installation, maintenance and operation of the equipment. This section contains safety information that must be observed at all times when working on or using the equipment.

In case of fire or other emergency:

If safe to do so, switch off the main or upst eam breaker for the panel.
Contact the fire department or other required emergency response team.
Evacuate the area and alert others in the area.

In case of unusual noise, smell or smoke:

Ensure nothing is in contact with the SPAN Remote Meter Kit, SPAN Panel, or other equipment.
Ventilate the space. Contact your installer or SPAN Customer Support.

Symbols Used

These symbols indicate important safety information in the documentation or on the equipment:

 **WARNING:** Indicates a situation where failure to follow instructions or use proper materials may be a safety hazard that may result in serious injury, loss of life, or destruction of equipment. Use caution and do not proceed until the indicated conditions or required procedures are fully understood and met.

 **CAUTION:** Indicates a situation where failure to follow instructions or use proper materials may be a safety hazard that may result in minor injury or damage to equipment. Do not proceed until the indicated conditions or required procedures are fully understood and met.

 **NOTE:** Indicates an important step or additional information that highlights best practices or procedures. Follow instructions carefully.

 **RISK OF ELECTRIC SHOCK:** Indicates components that present risk of electric shock.

 **PROTECTIVE CONDUCTOR TERMINAL:** Indicates location of grounding connection on the equipment.

 **REFER TO INSTRUCTIONS:** Indicates that user should refer to operating or installation instructions before proceeding.

ATTENTION: Read all instructions and cautionary markings in this document and on the equipment before installing SPAN Remote Meter Kit. Failure to do so may result in equipment damage, electric shock, serious injury, or loss of life. Failing to follow any of these instructions may also void the warranty. All installations must conform to the laws, regulations, codes and standards applicable in the jurisdiction of installation. Before starting an installation, consult a local building or electrical inspector for current requirements. Local codes may vary but are adopted and enforced to promote safe electrical installations. A permit may be needed to do electrical work, and some codes may require an inspection of the electrical work.

Jurisdiction:
United States

Code:
National Electrical Code (ANSI/NFPA 70)

General

-  **WARNING:** Risk of electric shock. Risk of fire. Only qualified electrical personnel should install, troubleshoot, service, or replace the equipment.
- WARNING:** Risk of electric shock. Apply appropriate personal protective equipment (PPE) and follow safe electrical work practices during installation and service. Turn off all power supplying this equipment before working on or inside equipment. Always use a properly rated voltage sensing device to confirm power is off. Replace all devices, covers, and doors before turning on power to the equipment.
- WARNING:** To protect the equipment and its components from damage when transporting, handle with care. To help prevent damage, leave all equipment in its shipping packaging until it is ready to be installed. Inspect the equipment for damage before installing. Do not install the equipment if it has been damaged in any way.
- WARNING:** Do not insert foreign objects into any part of the equipment. Do not put fingers into the electric vehicle connector. Do not forcefully fold or apply pressure to SPAN Remote Meter Kit or damage it with sharp objects.
- WARNING:** Do not attempt to open, disassemble, repair, tamper with, or modify the equipment other than what is permitted in this manual. The equipment contains no user-serviceable parts. Contact the installer who installed the equipment for any repairs. Only qualified electrical personnel should open SPAN Remote Meter Kit.

-  **CAUTION:** Do not use solvents to clean the equipment or expose the equipment to flammable or harsh chemicals or vapors. Do not allow petroleum-based paints, solvents, or sprays to contact nonmetallic parts of the equipment.
- CAUTION:** Do not use parts or accessories other than those specified for use with the equipment.

Installation and Use

-  **WARNING:** Risk of electric shock. Risk of fire. Only use electrical system components approved for wet locations.
- WARNING:** Risk of electric shock. Risk of fire. Ensure that all wiring is correct and that none of the wires are pinched or damaged. Before making any connections verify that the circuit breaker(s) are in the off position. Double check all wiring before applying power.
- WARNING:** Risk of electric shock. Improper servicing of the equipment or its components may result in a risk of shock or fire. To reduce these risks, disconnect all wiring before attempting any maintenance or cleaning. While connectors are rated for disconnect under load, it is best practice to de-energize before disconnecting.
- WARNING:** Risk of electric shock. Do not use equipment in a manner not specified by the manufacturer. Doing so may cause injury or loss of life, or damage to equipment.
- WARNING:** During normal meter operation, caution should be used when handling the following as high voltage may be present:
- Terminal Blocks
 - Current/Potential Transformer leads and the related circuits
 - All primary and secondary circuits may contain lethal current and voltage.
 - Contact with current channels must be avoided.
- WARNING:** Do not install or use SPAN Remote Meter Kit near flammable, explosive, harsh, or combustible materials, chemicals, or vapors. Install your charger in a sufficiently ventilated location and avoid areas with direct sunlight.
- WARNING:** SPAN Remote Meter Kit should be supervised when using around children.
- WARNING:** SPAN Remote Meter Kit must be grounded through a permanent wiring system or an equipment-grounding conductor.
- WARNING:** Take appropriate precautions with electronic medical implants. Contact your medical device manufacturer to find out any potential effects.
- WARNING:** SPAN Remote Meter Kit is only to be used for fixed installations and cannot be used as a portable device.
- WARNING:** SPAN Remote Meter Kit cannot be installed on the primary side of transformers or where VA has limitations. SPAN Remote Meter Kit can be only installed on the secondary side. Avoid contact with meter terminals after the completion of installation.
- WARNING:** Do not supply input voltage above the rated maximum limit of SPAN Remote Meter Kit and devices connected to it. Before energizing the meter, please refer to the meters label and specifications.
- WARNING:** Do not perform high voltage test or insulation experiments to output, input or communication terminals.
- WARNING:** The use of shorting blocks and fuses are recommended. Current transformers need to be grounded (5A/1A).

Environmental Conditions

-  **WARNING:** This equipment is intended for operation in an environment having a minimum temperature of -25°C (-13°F) and a maximum temperature of 70°C (158°F). Do not operate SPAN Remote Meter Kit in temperatures outside of its range.
- WARNING:** Install the equipment in a location that prevents damage from flooding. Ensure that no water sources are above or near the equipment, including downspouts, sprinklers, or faucets. If SPAN Remote Meter Kit was submerged in water due to flooding, have an electrician inspect your charger prior to use.

Maintenance

There are no parts within SPAN Remote Meter Kit that the user has to maintain. Only a qualified electrician may open and modify SPAN Remote Meter Kit.

If you want to clean your SPAN Remote meter Kit, we recommend that you use a soft, dry or damp cloth. Do not use a spray or direct water stream. Make sure that the power supply is turned off before you start cleaning.

For complete information on the AcuRev 1310 Series meter, visit www.accuenergy.com.

Contents

Datasheet	4		
Preparing to install	5	Installation	7
SPAN Remote Meter Kit Contents	5	Determine Wiring Entry	7
Installation Requirements	5	Mounting SPAN Remote Meter Kit	7
Required Equipment	5	Conduit & Electrical Wiring	7
Required Tools	5	Voltage Reference Wiring	8
Planning the Install Locations	6	CT Wiring	9
Mechanical & Environmental Requirements	6	Communications Wiring	10
Dimensions, Clearances, & Access	6	Final Inspection & Closing the Unit	10
		Commissioning	10
		Troubleshooting & servicing	11

Remote Meter Kit

The SPAN Remote Meter Kit is a stand-alone device to sense power and voltages outside of the SPAN Panel. Remote Meter Kit has revenue grade metering, integrated over-current protection and includes three current sensors. See installation guidance for details.

Performance Specifications

Input Range	100-415Vac, 50/60Hz
Connectivity	RS485 Connection to SPAN Panel

Mechanical Specifications

Dimensions	9.8 x 7.9 x 3.9 in (250 x 200 x 100 mm)
Mounting Options	Wall Mounted
Weight	3.8 lbs (1.73 kg)

Environmental Specifications

Operating Temperature	-13°F to 158°F (-25°C to 70°C)
Operating Humidity (RH)	5% to 95% Non-Condensing
Environment	Indoor and Outdoor (NEMA 4)

Compliance Information

Certifications	UL and cUL listed. NEC compliant.
----------------	-----------------------------------

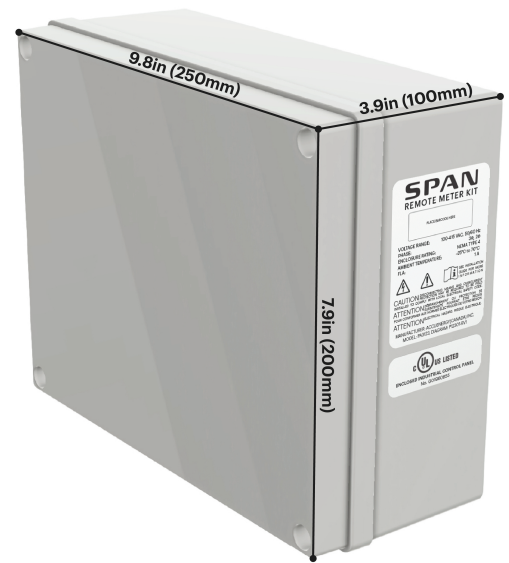

Compatibility

The Enphase IQ Battery will be the first storage system supported with the SPAN Remote Meter Kit. Other AC battery systems will follow – Please ask your SPAN representative for more info.

Become an Authorized Installer

Learn more at
www.span.io/partners

We envision a future where every home is electric and technologies like solar, batteries, and EV charging are commonplace. Our goal is to enable this transition by dramatically simplifying the adoption of clean energy solutions, many of which exist today. This is our decade to decarbonize—join us on our mission.

Preparing to install

SPAN Remote Meter Kit contents

Before beginning the installation of Remote Meter Kit, ensure you have received the following components:



Remote Meter



3x 200A Current Transformers (CTs) with 8' (2.4m) leads



1x Insulation Piercing Connector



If the unit is damaged in any way, do not proceed with the installation. Contact SPAN for further instructions.

SPAN Remote Meter must be installed by a licensed electrician. Before installing, be sure to obtain any required permits and/or approvals in accordance with applicable codes, regulations, and ordinances for electrical installations.

Installation requirements

You will also need the following equipment and tools that are not included with Remote Meter Kit:

Required Equipment

12 AWG copper conductors rated to a minimum of 75°C, such as THHN, THWN, NM-B, MC in Red, Black, White and Green (colors optional).

24–16 AWG (min. 22 AWG solid-core recommended) 3-wire (2 + Drain), minimum 300V rated, shielded, twisted-pair communication cable.

Conduit, conduit fittings, bushings that are suited to the installation.

Smartphone or tablet with SPAN Installer App for commissioning.

Personal Protective Equipment (PPE) should be worn by all persons at the installation site and properly rated for residential applications.

Required Tools

#2 Phillips screwdriver or bit, with extension

Electric drill

Uni-bit or minimum 3/4" plastic drill-bit

Mini flathead screwdriver

Standard installation tools: wire cutters/strippers, multimeter, stud finder, measuring tape

Planning the install location

Mechanical & environmental requirements

Remote Meter Kit is NEMA 4 rated and can be installed indoors or outdoors.

Remote Meter Kit is intended to be wall-mounted, ideally hitting a stud (2x4 or equivalent) with 4 screws.

Verify that the wall construction is adequate to support the weight (3.8 lbs) of Remote Meter Kit. The installation should conform to applicable building codes.

Element

Rating

Location	Indoor or Outdoor (NEMA 4)
Ambient Temperature	-13°F to 158°F (-25°C to 70°C)
Enclosure dimensions	9.8 x 7.9 x 3.9 in (250 x 200 x 100 mm)
Weight	3.8 lbs (1.73 kg)



Verify that the site mechanical, electrical, and clearance requirements outlined in this document and the product datasheet are compatible at the planned installation location. NEMA 4 rated conduit fittings are required for outdoor installations.

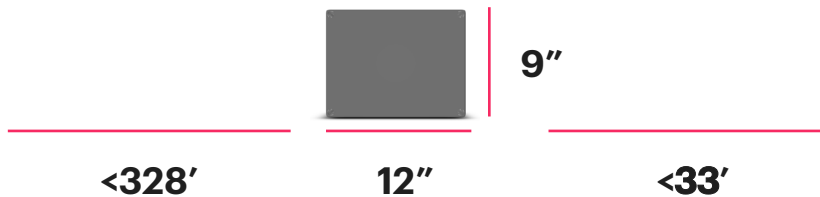

Dimensions, clearances, & access

Before beginning work, check the site for equipment layout and appropriate mounting location.

Install Remote Meter Kit a maximum of 328 feet (100 meters) from the SPAN Panel and a maximum of 33 feet (10 meters) from the Enphase Micro-grid Interconnect Device (MID).

Ensure there is at least 12 in x 9 in (30 cm x 23 cm) of flat wall space to mount Remote Meter Kit.



The included CTs have 8' (2.4m) integrated leads and can be extended to a maximum of 32' (10m).

Installation

Determine wiring entry

Remote Meter Kit requires a wiring entry point to be drilled into the plastic enclosure. Before proceeding with drilling the entry point, determine the most appropriate entry location based on the placement of wiring or conduit. Be sure to note the wiring terminal locations inside the enclosure when planning an entry point.



Follow all local codes and standards when planning for and installing SPAN Remote Meter Kit.



If Remote Meter Kit is mounted outdoors, use only bottom entry into the enclosure.

Mounting SPAN Remote Meter Kit

Depending on the material of the mounting wall, use the appropriate hardware and drill pilot holes as needed.

Using a #2 Phillips head screwdriver, unscrew the four plastic screws at the corners of the enclosure to remove the enclosure lid.

Screw the included metal mounting hardware onto the enclosure mounting standoffs on the backside of Remote Meter Kit.

Place the enclosure on the wall at the mounting location. Ensure that the enclosure rests evenly against the surface of the wall and use suitable wood/concrete screws to secure the enclosure to the wall.

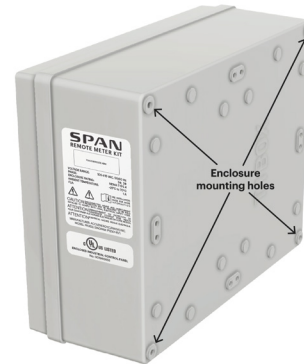

Conduit & Electrical wiring

Conduit is required between Remote Meter Kit and the Enphase MID. Whenever possible, utilize existing conduit/raceways for Remote Meter Kit wiring. If existing conduit cannot be used, install minimum 3/4" conduit.

Use appropriate cable glands or fittings to protect from water and debris intrusion.

Pull five 12 AWG conductors, CT leads (see "CT Wiring" on page 9 to determine the number of CTs required) and one RS485 communications cable through the conduit between Remote Meter Kit and the Enphase MID. Ensure there's enough wire length to reach the terminal blocks inside Remote Meter Kit. Check that conduit bushings are in place to avoid damage to conductors when pulled into the enclosures.



When combining both power and communication wiring together in the same raceway, ensure that the communications wire meets applicable requirements for NEC voltage rating and communications performance.

Voltage reference wiring

Voltage Inputs

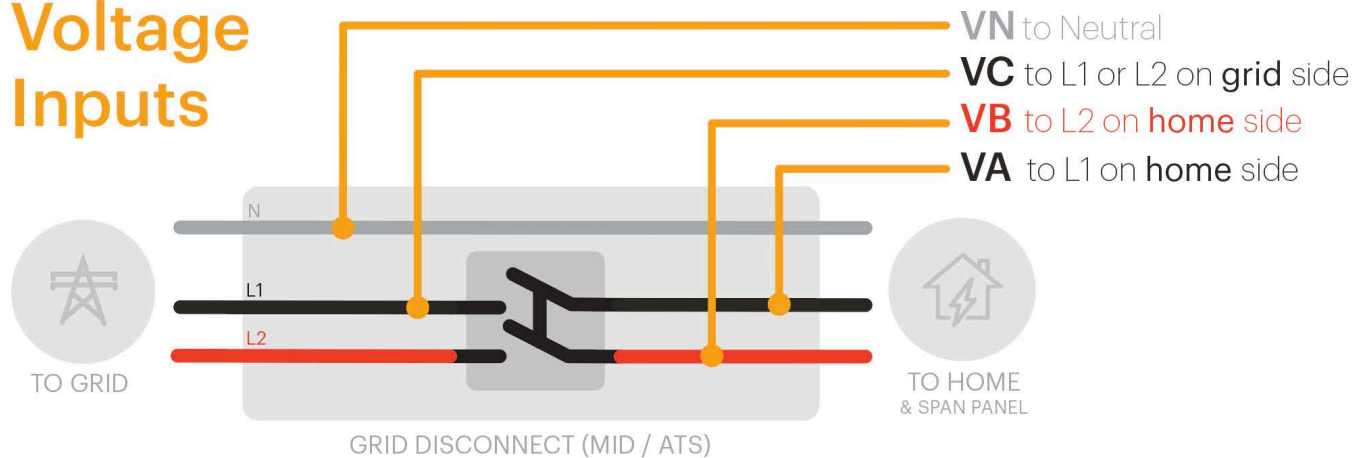

The five 12 AWG conductors pulled into Remote Meter Kit will be used as voltage references to sense grid state across the Enphase MID, as well as power the device.

Install the voltage reference wires from the Remote Meter Kit terminal blocks to either dedicated circuit breakers, or a combination of circuit breakers and the Insulation Piercing Connector provided with the Remote Meter Kit. Install the voltage reference wires as follows:

1. Grid side voltage reference on either L1 or L2 of the grid side of the Enphase MID. Land the grid voltage reference wire in the VC terminal block inside Remote Meter Kit.
2. Home side voltage references on both L1 and L2 of home side of the Enphase MID. Land the L1 home side voltage reference in the VA terminal block inside Remote Meter Kit, and the L2 home side voltage reference in the VB terminal block.
3. Neutral and Ground wires from the Remote Meter Kit terminal blocks into the Enphase MID Neutral and Ground bus bars.



In situations with limited circuit breaker space inside the Enphase MID, Remote Meter Kit voltage reference wires (VA and VB) can be landed on quad-tandem circuit breakers to replace the double-pole circuit breakers inside the Enphase MID.

CT Wiring

Remote Meter Kit has three CT inputs which can be used for a combination of Site, Solar, or Battery measurement. Determine which CT configuration to install as follows.

Terminal Block	CT1	CT2	CT3
Solar in SPAN Panel	Battery L1	Site L2	Site L1
Solar outside of SPAN Panel	Battery L1	Solar L2	—

Solar in SPAN Panel

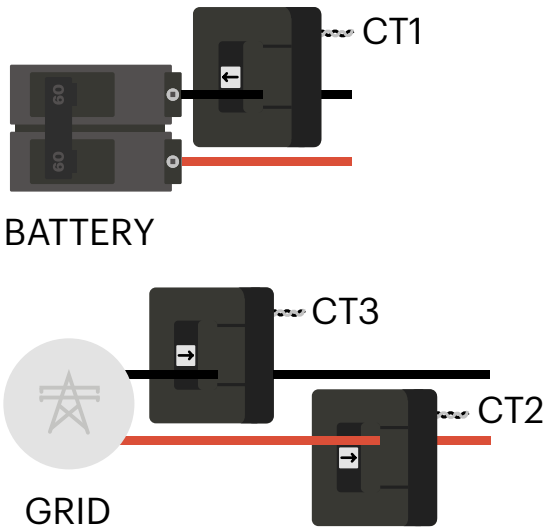

Solar outside of SPAN Panel

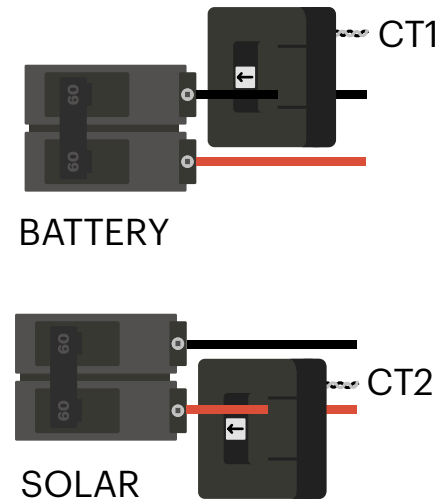

Three CTs used if Solar (IQ Combiner) circuits are in the SPAN Panel.

Solar (IQ Combiner) circuits landed in the SPAN Panel do not need a CT.

Battery circuits require 1 CT (L1 only). Terminate the leads of the battery CT in the CT1 terminal block inside Remote Meter Kit.

Site monitoring requires 2 CTs (L1 and L2). Terminate the leads of the site CTs in the CT2 and CT3 terminal blocks inside Remote Meter Kit.

Two CTs used if Solar (IQ Combiner) circuits are not in the SPAN Panel.

Battery circuits require 1 CT (L1 only). Terminate the leads of the battery CT in the CT1 terminal block inside Remote Meter Kit.

Solar (IQ Combiner) circuits require 1 CT (L2 only). Terminate the leads of the solar CT in the CT2 terminal block. Site CTs cannot be used, home consumption will only show what is measured in the SPAN Panel.

CTs are 200A rated with 0.75" openings, so multiple Battery or Solar circuits can be captured by a single CT.



Install each CT with the arrow pointing away from Solar / Battery sources and away from grid for Site CTs. Land the black (-) / white (+) leads of the CT in the corresponding colored terminal blocks.

Strip 3/8 (10mm) of insulation off each CT wire lead before inserting into the Remote Meter Kit terminal blocks.

Communications wiring

Connect the communication wire between the Remote Meter Kit RS485 terminals and the SPAN Panel RS485-3 terminals. Strip 3/8" (10mm) of insulation off each wire and fully insert into the terminal.

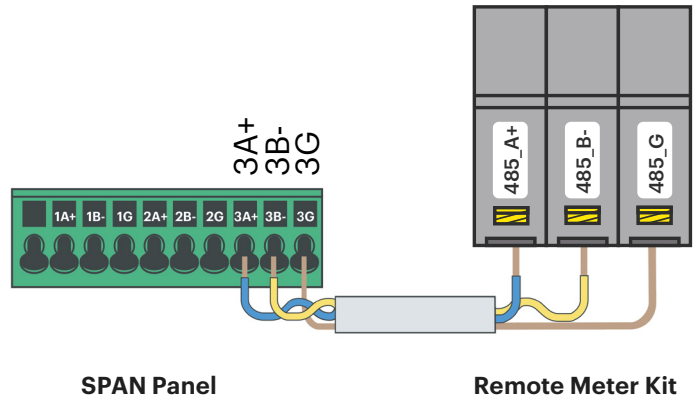

When combining both power and communication wiring together in the same raceway, ensure that the communications wire meets applicable requirements for NEC voltage rating and communications performance.

Final inspection & Closing the unit

Confirm that all wiring connections are correct and secure. Flip the Remote Meter Kit integrated circuit breaker on to provide power to the device. Reattach the lid onto the enclosure, do not over-tighten the plastic screws.

Commissioning

Remote Meter Kit must be configured with the SPAN Installer App prior to use. The serial number of the device can be found on the exterior right side of the enclosure or inside Remote Meter Kit.

Download the SPAN Installer App

span.io/span-apps

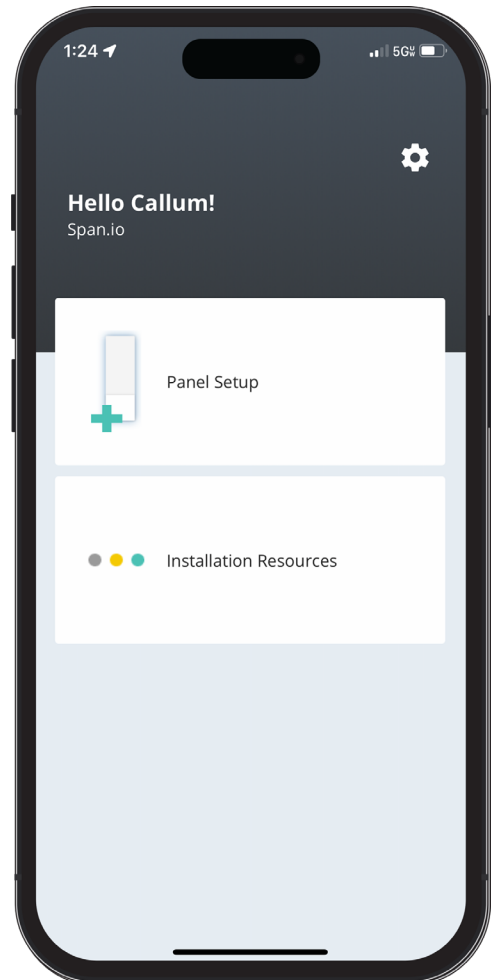

Troubleshooting & Service

For additional troubleshooting and support visit www.support.span.io or contact SPAN customer service at (415) 286-5252.

Need help?

<https://support.span.io/>

<https://www.span.io/tech-portal>



Do not attempt to open, disassemble, repair, tamper with, or modify the equipment.

The equipment contains no user-serviceable parts. Contact the installer who installed the equipment for any repairs. Only qualified electrical personnel should open SPAN Remote Meter Kit.

Symptom

What it means

How to fix

Remote Meter Kit LED is off

Remote Meter Kit does not have power

Check that the integrated circuit breaker inside Remote Meter Kit is flipped to the ON position. Confirm that the Enphase system is turned on and no grid outage is present.

Check with a multimeter that there is voltage measured at the Remote Meter voltage terminal blocks (120V VA/VB/VC to N). If no voltage present, confirm that all wire terminations are properly stripped and landed (on both Remote Meter Kit terminal blocks, and circuit breakers/voltage taps in Enphase MID).

If an Insulation Piercing Connector (IPC) is being used for any voltage references in the Enphase MID, ensure that the connector is properly torqued to pierce the insulation and make contact with the metal conductor. Ensure also that the voltage reference wires going from the IPC to Remote Meter Kit are properly landed and clamped in the IPC.

CT Powerflow readings are zero

CTs may not be making electrical contact in Remote Meter Kit terminal block

Verify current readings throughout the system with a multimeter to ensure that current is present.

Ensure that 3/8" (10mm) of insulation has been stripped off each CT lead before inserting in Remote Meter Kit CT terminal blocks, otherwise the pre-stripped length on the CTs will not make proper contact with the terminal block.

CT Powerflow reading polarity is reversed

CTs may be installed backwards or on the wrong phase of the conductors being measured

CTs may be installed backwards or on the wrong phase of the conductors being measured. Verify current readings throughout the system with a multimeter to understand true direction of current.

Ensure that the white arrow label on the CT is pointing away from the grid (for site CTs) and towards the circuit breaker (for battery and solar CTs)

Confirm that CTs are on the correct phase (L1, L2) according to this table:

Terminal Blocks:	CT1	CT2	CT3
Solar in SPAN:	Battery L1	Site L2	Site L1
Solar outside SPAN:	Battery L1	Solar L2	-

Revision log

Version

2023-03-17

Note

First Revision

INFORMATION SHEET

KUP-L-Tap, Insul-Eater Single Use Insulation Piercing Connectors WARNING USER MUST READ FOLLOW AND UNDERSTAND INSTRUCTIONS BEFORE INSTALLING

Item ID	Run	Tap	Torque (in-lbs)	Tools (Socket & Box wrenches)	Voltage
IPC-1/0-2	1/0 - #8 AWG	#2 - #8 AWG	192	1/2"	300 (480 grounded Y system)
IPC-4/0-6	4/0 - #4 AWG	#6 - #14 AWG	156	1/2"	600
IPC-4/0-2/0 * +	4/0 - #2 AWG	2/0 - #6 AWG	300	1/2"	600
IPC-250-4/0 * #	250 kcmil-#1 AWG	4/0 - #6 AWG	360	5/8"	600
IPC-350-4/0	350 kcmil-4/0	4/0 - #10 AWG	300	5/8"	300 (480 grounded Y system)
IPC-350-350	350 kcmil-4/0	350 kcmil-4/0	300	5/8"	300 (480 grounded Y system)
IPC-500-12	500-250 kcmil	#10 - #12 AWG	300	5/8"	300 (480 grounded Y system)
IPC-500-250	500-250 kcmil	250 - #4 AWG	720	5/8" & 11/16"	600
IPC-500-500 *	500-300 kcmil	500-250 kcmil	900	7/8"	600
IPC-750-500 *	750-500kcmil	500-350kcmil	900	7/8"	600

* Can be used on uninsulated conductor or uninsulated & insulated wire combinations (when used on uninsulated conductor, break out the tabs and extend the conductor 1.5" – 2" beyond the connector body.

+ Tap Wire side is limited to 0.528" outer diameter (O.D.) including the insulation

Max O.D. on the run conductor is 0.730" including the insulation

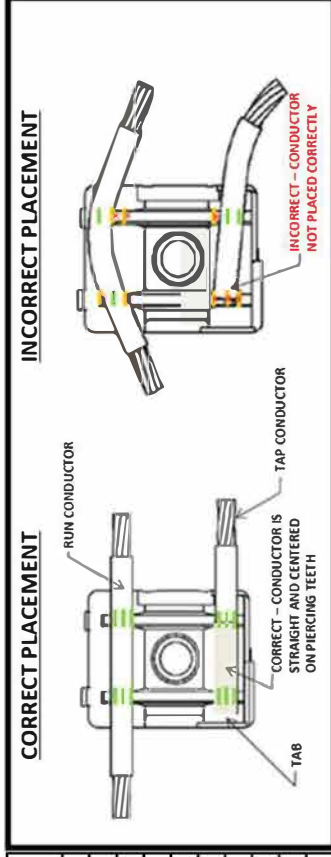

1) INSTALLATION INSTRUCTIONS FOR USE AS A RUN AND TAP:

- A) For continuous Run remove the tab blocking the Run conductor groove with a screwdriver or pliers. (Tab must be broken cleanly to the bottom of the channel with no sharp edges)
- B) Cut insulated Tap Conductor squarely and apply an approved insulating material over any end of a Conductor that will be exposed after installation
- C) Loosen the bolt to provide room for the Conductors to be installed in the connector
- D) Fully Insert the Conductors into the connector so that the conductors are centered on the piercing teeth.
- E) The tap Conductor needs to be fully inserted and make contact with the tab on the opposite side of the connector.
- F) The Connector must be installed on a section of Conductor with no bends or curves, see image for examples of correct placement and incorrect placement with Conductor centered in the connector slot.
- G) Holding the connector firmly, tighten the bolt to the required torque in the table above

2) IMPORTANT INFORMATION

- A) For use on insulation types up to 600v rated such as THHN, THWN, XHHW, XLPE. For insulation types not listed contact ILSCO Technical Services
- B) Not for use on Conductors including PV conductors with higher than 600v rating
- C) Not for use on Cloth insulated Conductors
- D) Not for use on a section of Conductor where an insulation piercing connector was previously installed and removed
- E) Connector must be installed on a straight section of Conductor only (Run, and Tap Conductors must also be centered in the connector see image for examples of correct placement and incorrect placement of conductors)
- F) Connector is for use with Class B & C Conductors only as identified in Chapter 9 Table 10 in the NEC
- G) IPC connectors are fully insulated without an external cover or other insulating material
- H) Not to be installed while Conductors are under load
- I) IPC connectors are for ONE TIME USE ONLY, (even if only partially torqued and removed the connector must be discarded and replaced)
- J) ONLY install this connector where there is sufficient room to install and properly apply the required torque in the table above

REV: C	MATERIAL: SEE NOTES 1 & 2
SCALE: 1:1	DRAWN BY: JG
SIZE: A	DATE: 2/11/2008

SCREW: 130257	PLATING: NONE
CAT. NO.: IPC-4/0-6 & IPC-4/0-6-B	MARKING: NONE
INFORMATION SHEET: FORM 73	

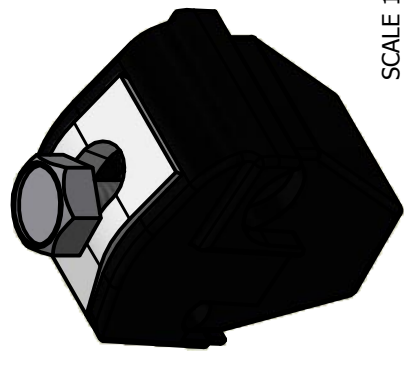
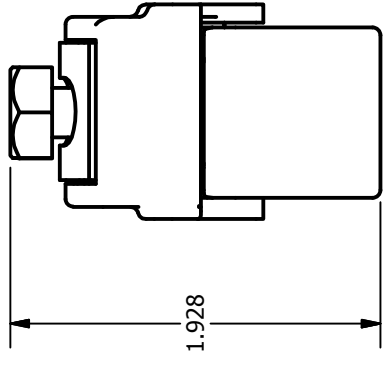
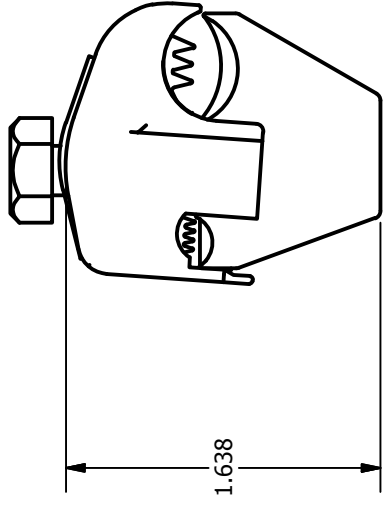
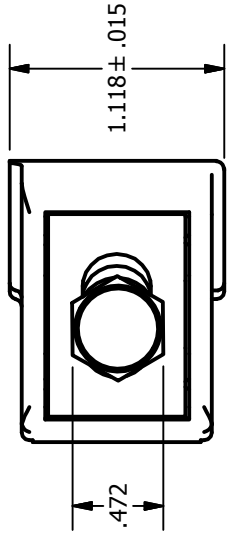

SCALE 1 : 1

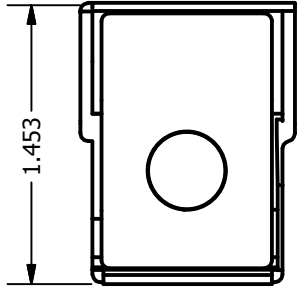

- NOTES:
1. NYLON BODY
 2. TIN PLATED COPPER TEETH
 3. WIRE RANGE: MAIN- 4/0 - 4
TAP- 6 - 14

MATERIAL SAFETY DATA SHEET

I. PRODUCT AND COMPANY IDENTIFICATION

Product Name: R6983-SILICON, 130240

Manufactured for and Distributed by:

ILSCO CORPORATION

4730 Madison Road

Cincinnati, OH 45227-1426

Issued: 04/07/1995 Revision 9 12/4/2012

Emergency Contact: INFOTRAC 1-800-535-5053

International Contact: INFOTRAC 1-352-323-3500

Contact Number: 103492

Date of Preparation: November 13, 2013

Trade Name: **PST-511, Silicone G661**

Product Type: Dielectric Silicone Compound

II. INGREDIENTS

<u>CAS #</u>	<u>T % Range</u>	<u>Component</u>
63148-62-9	85-95	Dimethyl Polysiloxane
112945-52-5	5 – 15	Silicon Dioxide

III. HAZARDS IDENTIFICATION

Eyes: Contact with eyes during product use may result in mild irritation.
Skin: Contact with skin from a single short-term exposure is not expected to result in irritation. Repeated or prolonged exposure may cause irritation.
Inhalation: No significant effects expected from a single short-term exposure. No known applicable information for long term exposure.
Oral: Repeated ingestion or swallowing large amounts may injure internals.

Carcinogenicity: NTP: NO IARC Monographs: NO OSHA Regulated: NO

IV. FIRST AID MEASURES

Eye: Flush eyes with large amounts of water. If signs/symptoms persist, get medical attention. Obtain medical attention.
Skin: Wash affected area with soap and water. If signs/symptoms persist, get medical attention. No need for first aid is anticipated.
Inhalation: If signs/symptoms develop, remove person to fresh air. If signs/symptoms persist, get medical attention.
If Swallowed: If irritation or discomfort occurs, obtain medical assistance.

V. FIRE FIGHTING MEASURES

Autoignition Temperature: >300°C
Flash point: >300°C
Flammable Limits (LEL) Not determined
Flammable Limits(UEL) Not determined

MATERIAL SAFETY DATA SHEET

Extinguishing Media: On large fires used dry chemical, foam, or water spray. On small fires use carbon dioxide, dry chemical, or water spray. Water can be used to cool fire exposed containers.

Unusual Fire and Explosion Hazards: None.

VI. ACCIDENTAL RELEASE MEASURES

Environmental precautions: For larger spills, cover drains and build dikes to prevent entry into sewer systems or bodies of water. Collect the resulting residue containing solution. Place in a metal container approved for transportation by appropriate authorities. Dispose of collected material as soon as possible.

Clean-up methods: Observe precautions from other sections. Contain spill. Working from around the edges of the spill inward, cover with bentonite, vermiculite, or commercially available inorganic absorbent material. Mix in sufficient absorbent until it appears dry. Collect as much of the spilled material as possible. Clean up residue with an appropriate solvent. Seal the container.

VII. HANDLING AND STORAGE

Handling: Avoid contact with skin or inhalation of mist. See section 8 for personal protection equipment. Practice good personal hygiene to prevent accidental ingestion after handling. Properly dispose of clothing that cannot be decontaminated.

Storage: Store away from oxidizing materials.

VIII. EXPOSURE CONTROLS/PERSONAL PROTECTION

Engineering Controls: No special local ventilation needed. General ventilation recommended.

Personal Protective Equipment (PPE):

Eyes: Safety glasses recommended.

Skin: Avoid prolonged or repeated skin contact. Wash hands after handling and before eating.

Inhalation: No respiratory protection required.

IX. CHEMICAL AND PHYSICAL PROPERTIES

Vapor Pressure	Negligible
Vapor Density	>10 (Air = 1)
Soluble in Water	Insoluble
Specific Gravity	~1.0 g/cm ³
Boiling Point:	>300°C
Volatile Organic Compound %	Negligible
pH	N/A (Insoluble)
Appearance	Translucent paste
Flash Point:	>300°C
Melting Point:	>260°C
Solubility in Water:	Negligible
Evaporation Rate	Negligible
Volatile Content:	Negligible

X. STABILITY AND REACTIVITY

Stability: Stable

Hazardous Polymerization: Will not occur.

Incompatibilities: Oxidizing agents.

Hazardous Decomposition: At elevated temperatures silicon oxides, CO, and CO₂ can form.

MATERIAL SAFETY DATA SHEET

XI. TOXICOLOGICAL INFORMATION

Acute Toxicity: Non-toxic
Skin Sensitization: Not expected to cause skin sensitization.
Chronic Toxicity: No known carcinogens, mutagens, or reproductive toxins (CMR) present.

XII. ECOLOGICAL INFORMATION

Chemical Fate:
Complete information is not yet available.
Aquatic:
Complete information is not yet available.

XIII. SPILL AND DISPOSAL PROCEDURES

Reclaim if feasible. Incinerate in an industrial or commercial facility in the presence of a combustible material. As a disposal alternative, dispose of product in a facility permitted to accept chemical waste.

EPA Hazardous Waste Number (RCRA): Not regulated.

XIV. TRANSPORT INFORMATION

Class or Type: US DOT, IMO, and IATA: Non-Hazardous

XV. REGULATORY INFORMATION

311/312 Hazard Categories:

Fire Hazard: No
Pressure Hazard: No
Reactivity Hazard: No
Immediate Hazard: No
Delayed Hazard: No

The components of this product are in compliance with the chemical notification requirements of TSCA.

XVI. OTHER INFORMATION

NFPA Hazard Classification:

Health: 1
Flammability: 1
Reactivity: 0
Special Hazards: None

National Fire Protection Association (NFPA) hazard ratings are designed for use by emergency personnel to address the hazards that are presented by short-term, acute exposure to material under conditions of fire, spill, or similar emergencies. Hazard ratings are primarily based on inherent physical and toxic properties of the material but also include the toxic properties of combustion or decomposition products that are known to be generated in significant quantities.

HMIS Hazard Classification:

Health: 1
Flammability: 1
Reactivity: 0
Protection: B (See PPE section)

Hazardous Material Identification System (HMIS) hazard ratings are designed to inform employees of chemical hazards in the workplace. The ratings are based on inherent properties of the material under expected conditions of normal use and are not intended for use in emergency situations.

MATERIAL SAFETY DATA SHEET

These data are offered in good faith as typical values and not as product specifications. No warranty, either expressed or implied, is hereby made. The recommended industrial hygiene and safe handling procedures are believed to be generally applicable. However, each user should review these recommendations in the specific context of the intended use and determine whether they are appropriate.