

SPAN



Span Panel Installation Manual

for 2nd Generation models (1-00800-xx)

WWW.SPAN.IO

PRODUCT SPECIFICATIONS

All specifications and descriptions contained in this document are accurate at the time of publication. In the interest of product improvement, Span reserves the right to make product modifications at any time without advance notice.

For the latest Span product and installation documents, visit:
www.span.io/partner-portal

For errors or omissions, contact support@span.io

For complete product specifications and information on product listing and certification, refer to the Product Datasheet at www.span.io.

Span assumes no liability for injury or property damage due to installation or service attempted by unqualified individuals, or due to a failure of installers or service technicians to properly follow safety, installation and service instructions.

© 2021 Span.IO, Inc. All rights reserved.

All information in this document is subject to copyright and other intellectual property rights of Span.IO, Inc. This material may not be modified, reproduced or copied, stored in a retrieval system, or transmitted, in whole or in part, without the prior written permission of Span.IO. Additional information is available upon request.

Trademarks

The following are trademarks or registered trademarks of Span in the United States and other countries.



All other trademarks in this document are the property of their respective owners, and their use within does not imply endorsement of their products or services. The unauthorized use of any trademark displayed in this document or on the product is strictly prohibited.

Electronic Device Waste Disposal

Proper disposal of electronic equipment is required. Refer to local codes for disposal requirements. To arrange for proper disposal of this product, contact your local authorities or dealer for proper disposal requirements.

Warranty

To secure the full product warranty, the Span Panel must be registered by completing the commissioning process, which sends system information to Span. For complete warranty information, refer to the Product Warranty at www.span.io.

IMPORTANT SAFETY INSTRUCTIONS

SAVE THESE INSTRUCTIONS

Follow these instructions during installation, maintenance and operation of the equipment. This section contains safety information that must be observed at all times when working on or using the equipment.

In Case of Fire or other emergency:

If safe to do so, switch off the main or upstream breaker for the panel.
 Contact the fire department or other required emergency response team.
 Evacuate the area and alert others in the area.

In case of unusual noise, smell or smoke:

Ensure nothing is in contact with the Span Panel or other equipment.
 Ventilate the space.
 Contact your installer or Span Customer Support.

Symbols Used

These symbols indicate important safety information in the documentation or on the equipment:

	WARNING: Indicates a situation where failure to follow instructions or use proper materials may be a safety hazard that may result in serious injury, loss of life, or destruction of equipment. Use caution and do not proceed until the indicated conditions or required procedures are fully understood and met.
	CAUTION: Indicates a situation where failure to follow instructions or use proper materials may be a safety hazard that may result in minor injury or damage to equipment. Do not proceed until the indicated conditions or required procedures are fully understood and met.
	NOTE: Indicates an important step or additional information that highlights best practices or procedures. Follow instructions carefully.
	RISK OF ELECTRIC SHOCK: Indicates components that present risk of electric shock.
	PROTECTIVE CONDUCTOR TERMINAL: Indicates location of grounding connection on the equipment.
	REFER TO INSTRUCTIONS: Indicates that user should refer to operating or installation instructions before proceeding.

ATTENTION: Read all instructions and cautionary markings in this document and on the equipment before installing the Span Panel. Failure to do so may result in equipment damage, electric shock, serious injury, or loss of life. Failing to follow any of these instructions may also void the warranty.

All installations must conform to the laws, regulations, codes and standards applicable in the jurisdiction of installation. Before starting an installation, consult a local building or electrical inspector for current requirements. Local codes may vary but are adopted and enforced to promote safe electrical installations. A permit may be needed to do electrical work, and some codes may require an inspection of the electrical work.

Jurisdiction	Code
United States	National Electrical Code (ANSI/NFPA 70)

General

	<p>WARNING: Risk of electric shock. Risk of fire. Only qualified electrical personnel should install, troubleshoot, service, or replace the equipment.</p> <p>WARNING: Risk of electric shock. Apply appropriate personal protective equipment (PPE) and follow safe electrical work practices during installation and service. Turn off all power supplying this equipment before working on or inside equipment. Always use a properly rated voltage sensing device to confirm power is off. Replace all devices, covers, and doors before turning on power to the equipment.</p> <p>WARNING: To protect the equipment and its components from damage when transporting, handle with care. To help prevent damage, leave all equipment in its shipping packaging until it is ready to be installed.</p> <p>WARNING: Inspect the equipment for damage before installing. Do not install the equipment if it has been damaged in any way.</p> <p>WARNING: Do not insert foreign objects into any part of the equipment.</p> <p>WARNING: Do not expose the equipment or any of its components to direct flame.</p> <p>WARNING: Do not attempt to open, disassemble, repair, tamper with, or modify the equipment other than what is permitted in this manual. The equipment contains no user-serviceable parts other than field-installed circuit breakers. Contact the installer who installed the equipment for any repairs.</p> <p>WARNING: Do not connect life-support systems, other medical equipment, or any other use where product failure could lead to injury to persons or loss of life to circuits which can be remotely switched.</p>
	<p>CAUTION: Do not use solvents to clean the equipment or expose the equipment to flammable or harsh chemicals or vapors. Do not allow petroleum-based paints, solvents, or sprays to contact nonmetallic parts of the equipment.</p> <p>CAUTION: Do not use parts or accessories other than those specified for use with the equipment.</p>

Installation and Use

	<p>WARNING: Risk of electric shock. Risk of fire. Only use electrical system components approved for wet locations.</p> <p>WARNING: Risk of electric shock. Risk of fire. Ensure that all wiring is correct and that none of the wires are pinched or damaged.</p> <p>WARNING: Risk of electric shock. Risk of fire. Before making any connections verify that the circuit breaker(s) are in the off position. Double check all wiring before applying power.</p> <p>WARNING: Risk of electric shock. Improper servicing of the equipment or its components may result in a risk of shock or fire. To reduce these risks, disconnect all wiring before attempting any maintenance or cleaning.</p> <p>WARNING: Risk of electric shock. Always de-energize the equipment before servicing. While connectors are rated for disconnect under load, it is best practice to de-energize before disconnecting.</p> <p>WARNING: Risk of electric shock. Do not use equipment in a manner not specified by the manufacturer. Doing so may cause injury or loss of life, or damage to equipment.</p> <p>WARNING: Risk of electric shock. To maintain the warranty, do not modify the deadfront other than to remove filler plates as needed.</p>
	<p>NOTE: The equipment is intended to operate with a connection to the internet. Failure to maintain an internet connection may impact performance.</p> <p>NOTE: This device complies with part 15 of the FCC Rules. Operation is subject to the following two conditions: (1) This device may not cause harmful interference, and (2) this device must accept any interference received, including interference that may cause undesired operation. Changes or modifications not expressly approved by the party responsible for compliance could void the user's authority to operate the equipment.</p>

Environmental Conditions

	<p>WARNING: This equipment is intended for operation in an environment having a minimum temperature of -30°C (-22°F) and a maximum temperature of 50°C (122°F).</p> <p>WARNING: Install the equipment in a location that prevents damage from flooding. Ensure that no water sources are above or near the equipment, including downspouts, sprinklers, or faucets.</p>
--	---

CONTENTS

ABOUT YOUR SPAN PANEL

PREPARING TO INSTALL

1. Unpacking and Inspecting the Panel
2. Installation Requirements
3. Planning the Install Location

INSTALLATION

1. Mounting the Panel
2. Using the Panel as Service Equipment
3. Selecting Breakers
4. Wiring the Panel
5. Communication Wiring
6. Configuring the Door Swing Direction
7. Installing the Flush Mount Trim Kit
8. Final Inspection and Closing the Unit
9. Commissioning

TROUBLESHOOTING & SERVICING

APPENDIX A: CIRCUIT BREAKER COMPATIBILITY

ABOUT YOUR SPAN PANEL

The Span Panel is an intelligent breaker panel with integrated connectivity, monitoring, and control for home loads, solar PV generation, energy storage, electric vehicle charging equipment, and the utility grid. Span is wall-mounted and similar in size, weight, and configuration to traditional electrical panels, allowing it to be installed in place of a typical 120/240VAC breaker panel using standard tools and materials.

Span Panel installations can be designed to support both DC-coupled energy storage systems (where the solar generation and battery storage systems are managed by a single inverter) and AC-coupled systems (where the solar generation and battery storage systems each have their own inverter). See **Storage System Integration Manual** for complete details.

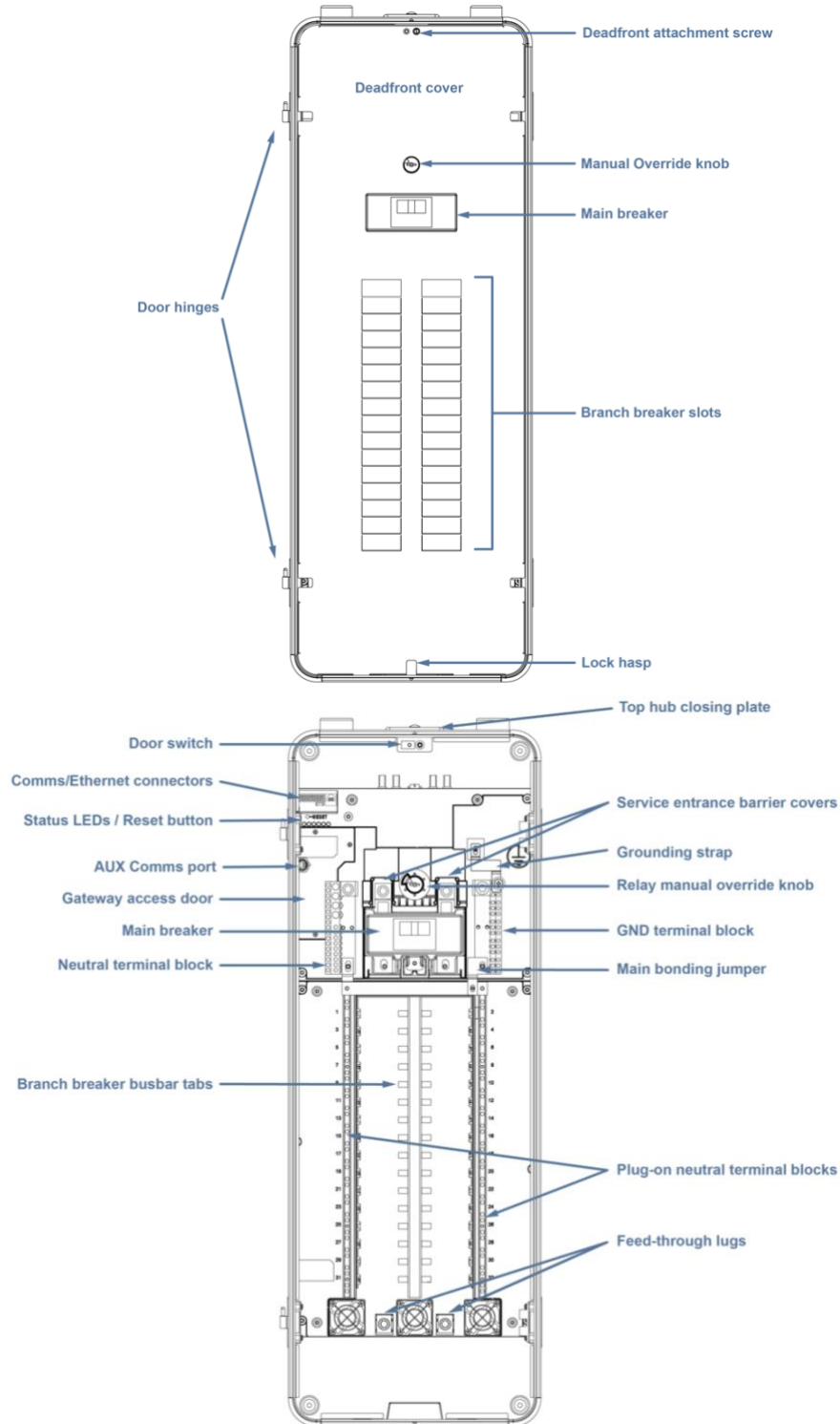

Span Panel with door removed (top), deadfront removed (bottom)

PREPARING TO INSTALL

1. Unpacking and Inspecting the Panel

Inspect the packaging and Span Panel for damage. Ensure you have received the following components:

- Span Panel (with main bonding jumper pre-installed) and door (packaged separately)
- Getting Started card (with instructions for homeowner to download Span Home App)
- Breaker label schedule sheet
- Accessories:
 - (1) Conduit hub closing plates (SquareD ACPCP) (pre-installed)
 - (2) SquareD service entrance barrier covers (pre-installed)
 - SquareD 200 A main breaker (pre-installed)
 - Spare fastener kit



WARNING: If the unit is damaged in any way, do not proceed with the installation. Contact Span for further instructions.

2. Installation Requirements

Internet Connection

The Span Panel requires an internet connection to enable monitoring and control features, and to receive the latest software updates.

Be sure to register the product to establish communication with Span. Failure to do so may affect product performance or affect the terms of the warranty. If a Wi-Fi signal is not available at the install location, establish an Ethernet connection between the Span Panel and the customer's router. Cellular LTE should only be relied on as a backup connection.

Required Equipment

- Branch circuit breakers for load and generation circuits. See [Selecting Breakers](#).
- Main breaker (100–200 A) using SquareD type QOM2 breakers
- Conduit, conduit fittings, and SquareD A-Series threaded conduit hub suited to the installation
- Four #10 lag bolts or screws, 3 inches long (depending on attachment wall) for panel mounting, and washers (for use between fasteners and enclosure)
- Conductors rated to minimum of 75°C. See table below and markings on breakers for acceptable wire gauge.
- Cable for communication between the Span Panel and solar inverter(s) (Minimum 300 V rated, shielded, twisted-pair, copper, 22–16 AWG)
- Smartphone or tablet with Span Installer App for commissioning

Personal Protective Equipment (PPE) should be worn by all persons at the installation site and properly rated for residential applications.

Required Tools

- Torquing tools capable of 20–275 in-lbs (2.3–31.1 Nm)
- Allen bits (3/8-inch and 5/16-inch)
- Phillips, slotted, and square-drive driver
- Standard installation tools: wire cutters/strippers, multimeter, stud finder, level, tape measure, marker, and flashlight



NOTE: Verify that the site mechanical, electrical, and clearance requirements outlined in this document and the product datasheet are compatible at the planned installation location.

NOTE: Install only compatible circuit breakers, hubs, conductors, and other accessories. Failure to do so may affect safety, product performance, and may void the warranty.

NOTE: NEMA 3R rated conduit fittings are required for outdoor installations.

NOTE: For 22 kA short-circuit rating, branch breakers must be series-listed with the SquareD main breaker. Otherwise, rating will be 10 kA.

3. Planning the Install Location

Electrical, Mechanical, and Environmental Requirements

- The Span Panel is service entrance rated. When used as service equipment, primary overcurrent protection for the site is required in the form of an installed main breaker not to exceed 200 A.
- The Span Panel is intended to be wall-mounted between studs (2x4' or equivalent) with 16-inch spacing, using all 4 mounting points. It is typically mounted semi-flush, so the front of the unit extends slightly beyond the surface of the wall.
- Verify that the wall construction is adequate to support the weight of the panel. The installation should conform to applicable building codes. Consult a structural engineer and local standards for local mounting requirements.

Element	Rating
Site Electrical Service	240/120 V, 60 Hz split-phase
Service Feed	225 A maximum
Internal Bussing	225 A maximum
Overcurrent Protection (Main Breaker)	100 - 200 A
Location	Indoor or Outdoor (NEMA 3R)
Ambient Temperature	-22°F to 122°F (-30°C to 50°C) <i>recommend out of direct sun</i>
Enclosure Dimensions	998 x 362 x 153 mm (39.3 x 14.3 x 6.0 in)
Flush Trim Kit Dimensions (on wall)	1123 x 405 mm (44.2 x 15.9 in)
Weight (without circuit breakers)	34 kg / 75 lbs (38 kg / 84 lbs fully populated with breakers)



CAUTION: Follow all local codes and standards when planning for and installing the Span Panel.

CAUTION: Do not exceed panel capacity. Ensure that the installation conforms to applicable code, and that appropriate overcurrent protection is in place.

Dimensions, Clearances, and Access

- Do not install the Span Panel near an emergency exit or other building evacuation route.
- Do not install the Span Panel in a location or place any objects near it that would prevent its door from opening to 90°, or that would restrict access to the unit.
- Do not mount objects on the wall within the minimum required clearances indicated below, with the exception of items required by the installation, such as electrical conduit or junction boxes.
- Do not recess the Span panel beyond the door hinges.



NOTE: The door may be configured to open from either direction. Ensure door may swing open to 90° per NEC 110.26(A)(2)

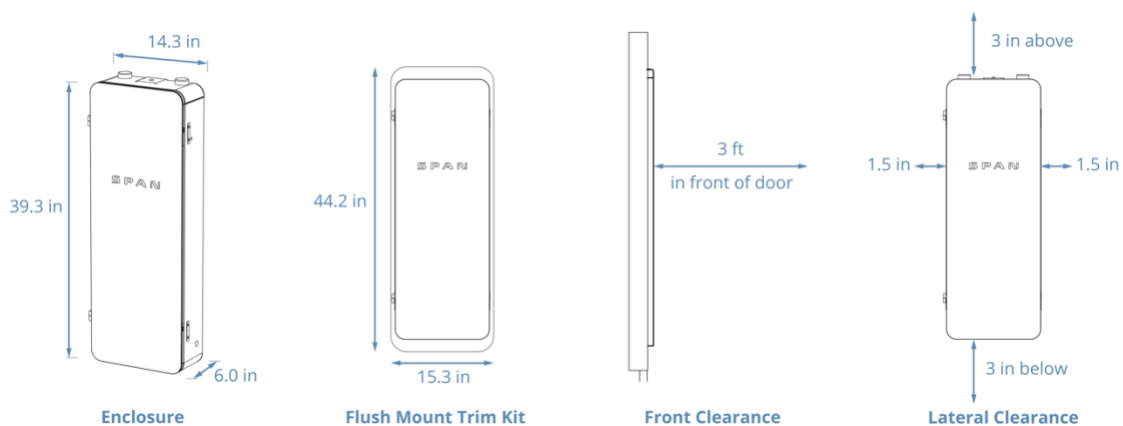

Accessories

The following accessories may be used with Span Panels:

Part	Manufacturer Part Number
Span Flush Mount Trim Kit	Span PN: 1-01046
Span Networking Kit (for multi-panel sites)	Span PN: 1-00921
Service entrance barrier cover	SquareD PN: PKSB1HA
Top hub closing plate	SquareD PN: ACPCP
Top threaded conduit hub, rainproof	SquareD A series hubs
Filler plate for branch breaker knockouts	SquareD PN: HOMFPCP
Add-on Neutral / GND lugs (Field-installed)	Siemens ECLK2 Siemens ECLK3 Eaton NL30 SquareD HOM100AN GE TLK20
Add-on GND bar kit (Field-installed)	UL Recognized ground bars may be installed by tapping threaded holes in the Span Panel enclosure, according to NEC requirements.
Powerline Ethernet Adapter Kit	Recommended options: TP-Link AV1000 TP-Link AV600

INSTALLATION

1. Mounting the Panel

Remove the Deadfront

- Using a flat screwdriver, loosen the single deadfront fastener screw and remove the deadfront cover.

Mount the Unit

- Ensure the wall space can accommodate the flush section without interference from pipes or conductors inside the wall space.
- Using a drill and level, mount the Span Panel enclosure on the wall, observing site and mechanical requirements, and applicable building codes. Secure the unit at all 4 mounting points.
- When flush mounting, drill ¼" pilot holes, marked by interior markings of the panel. Install fasteners through the side walls to secure the panel to the studs, as shown below.

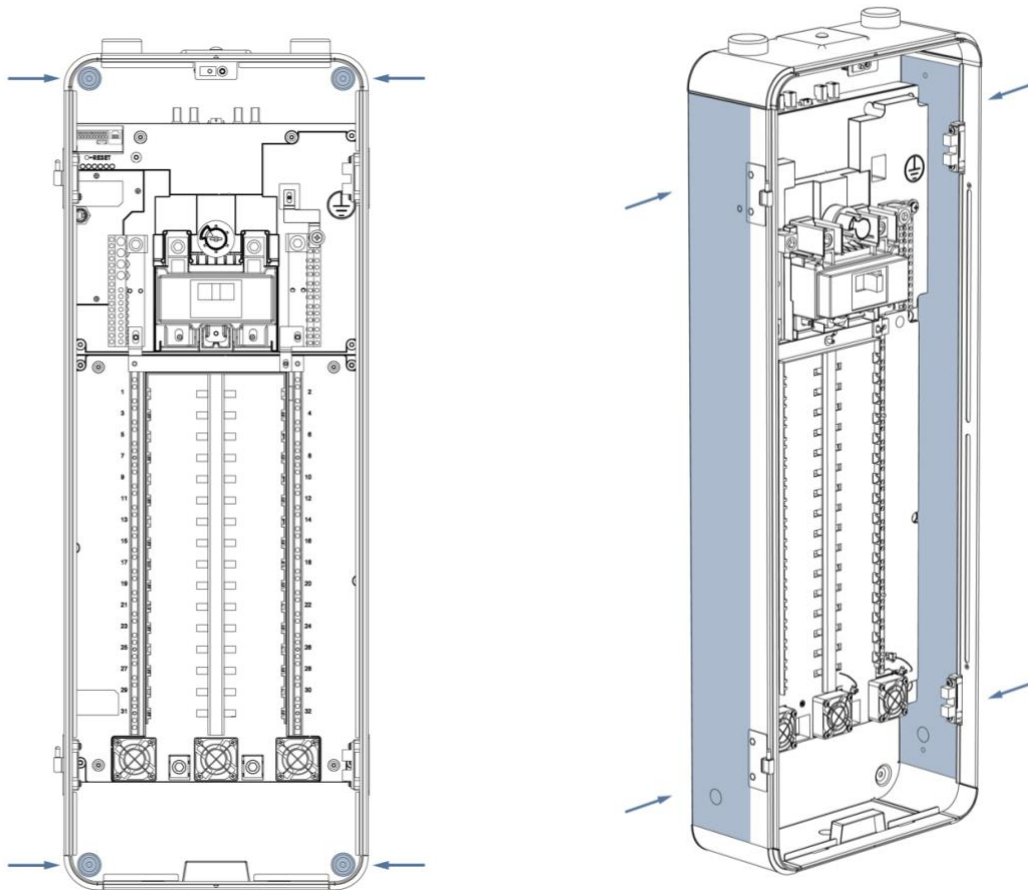

Wall Mounting Points for Surface-Mount (left) and Flush-Mount (right)



WARNING: Risk of electric shock. If you are replacing an existing electrical panel, make sure power is turned off before removing the old panel and when installing the Span Panel. Always make sure all electrical equipment is safely de-energized before beginning work



CAUTION: The unit must be installed within 10 degrees of vertical, and level from side-to-side.

Install Conduit

- The Span Panel allows conduit entry through the top, bottom, lower sides, and rear section of the panel.
- For top conduit entry, install a SquareD A-series threaded hub.
- Before removing knockouts, plan conduit routes and corresponding knockout locations and sizes on the enclosure. Be sure to allow adequate clearance for conduit routing and anchoring. Conduit installation must comply with applicable fill limits and electrical codes.

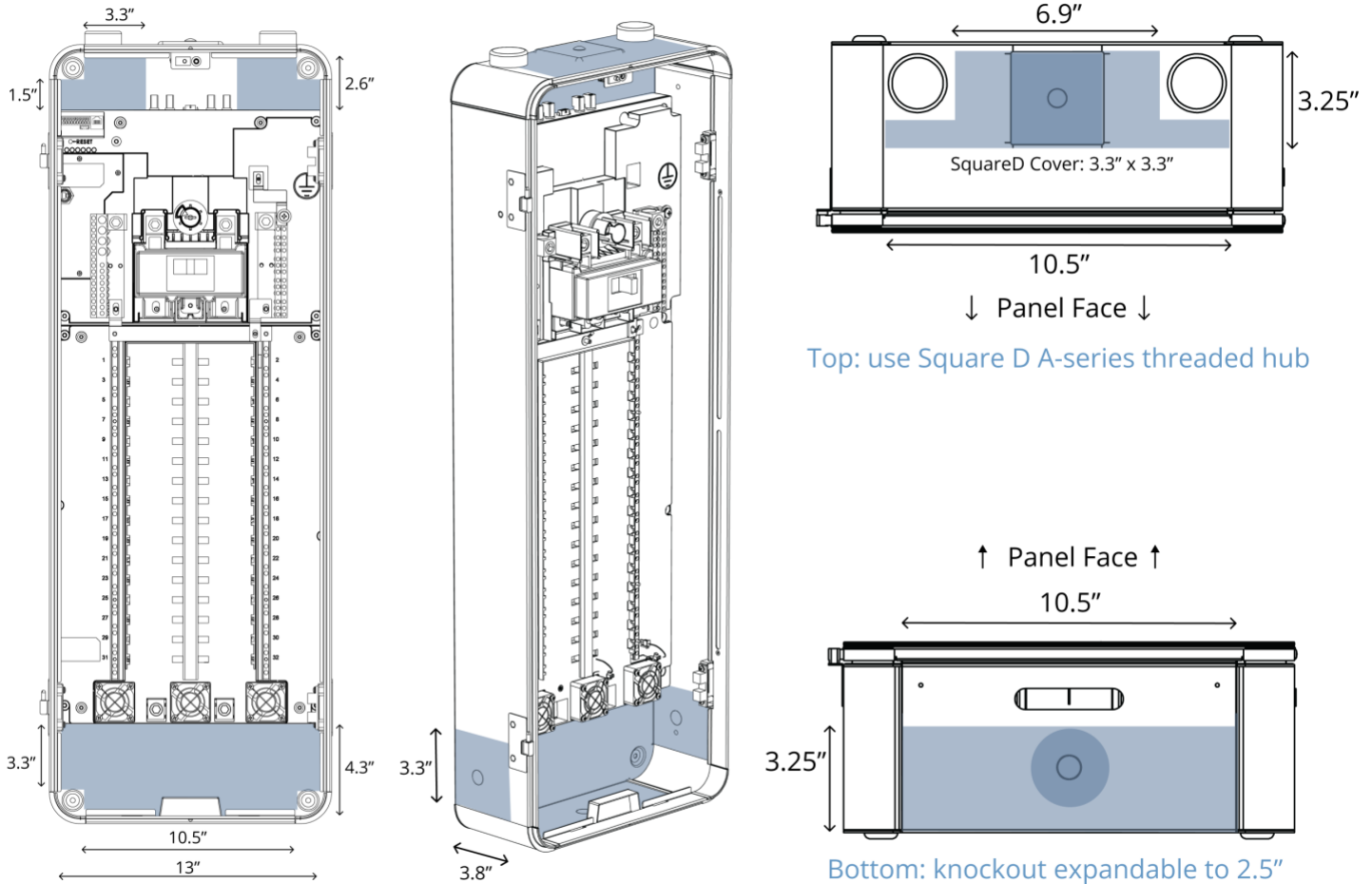

Allowable Conduit Entry Locations (shown in blue)



CAUTION: Do not punch conduit holes in any location on the enclosure that would allow moisture to enter the unit.

CAUTION: Follow guidance in NEC Chapter 3 and any local AHJ requirements for cable type selection. Consider exterior surface and flush mounted installations as wet/damp conditions and use conduit accordingly. When installed in wet/damp locations cable routed through the bottom face must be wet- or damp-rated.



NOTE: Additional conduit holes can be punched in the top sections of the panel. Note the locations of antennas and wires inside the panel before cutting. Be careful to keep metal shards from coming into contact with any energized parts. Use appropriate fittings for the location.

NOTE: Use care when drilling and confirm that fittings are the correct size and NEMA rating for the installation location before proceeding.

NOTE: When top conduit entry locations are not used for wire entry, it must be sealed properly with top hub closing plate.

2. Using the Panel as Service Equipment

Verify Neutral-to-Ground Bonding

- When used as service equipment, ensure the factory-installed main bonding jumper is securely in place.
- When **not** used as service equipment, remove the main bonding jumper.

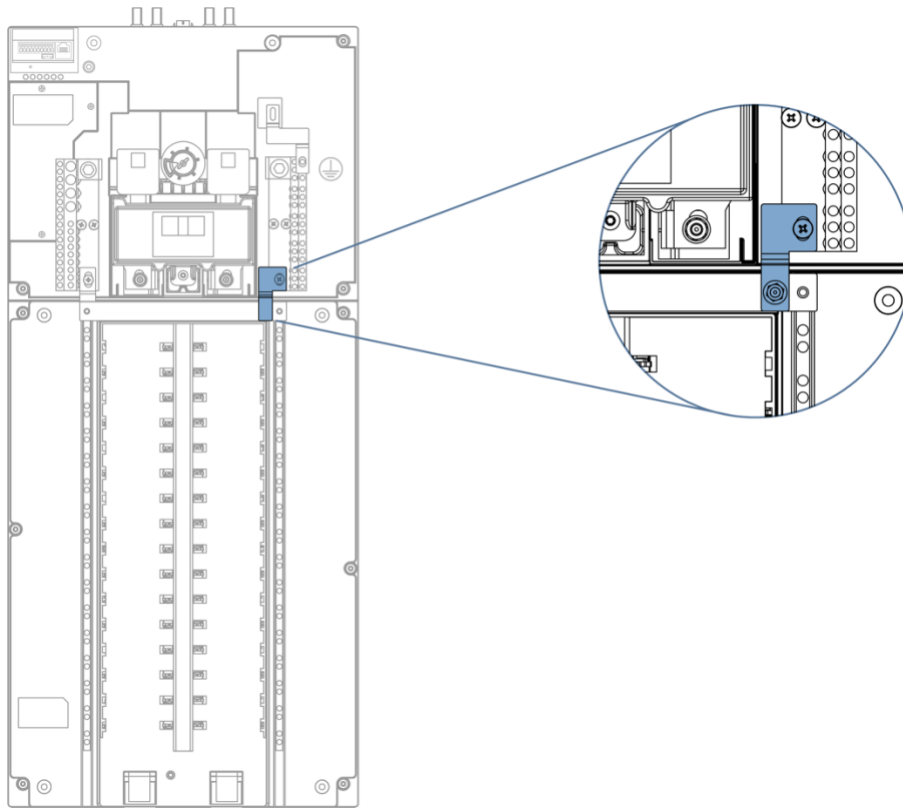

Location of bonding jumper in Span Panel



WARNING: When the Span Panel is not installed as service equipment, the factory-installed main bonding jumper **MUST** be removed. In this case, ensure Neutral and Ground are properly bonded at the upstream service equipment.



CAUTION: Do not modify or rewire any factory-installed connections except the main bonding jumper.



NOTE: When the Span Panel is installed as service equipment, ensure the panel's main breaker is appropriately labeled as "SERVICE / MAIN DISCONNECT"

3. Selecting Breakers

- The Span Panel accepts a 100–200 A main breaker and up to 32 branch breakers in the panel for load circuits.
- Install each branch breaker by rocking it down to seat it fully onto the busbar stab and engaging the clips that hold it in position. Ensure each breaker is firmly in place.



CAUTION: Install only listed and labeled circuit breakers compatible with the Span Panel. Branch circuits must not exceed the load limits specified below.

Maximum Load per Branch Circuit

Load Type	Maximum Load
General Use	90 A
Full Load Inductive/Motor Amps	60 A
Locked Rotor Inductive/Motor Amps	270 A

Breakers Listed for Use

Span is multi-listed for use with 1-inch (2.54 cm) standard, tandem, AFCI, and GFCI branch circuit breakers from Siemens/Murray, Eaton, and SquareD types listed in table below.

Branch Circuit Breakers (1-inch plug-in style, including AFCI/GFCI)*	Main Circuit Breaker
<ul style="list-style-type: none"> • SquareD type HOM, HOMT (including plug-on neutral style) • Eaton type BR, BD, BQ • Siemens/Murray type QP, QT 	SquareD QOM2 type: <ul style="list-style-type: none"> • 100 A QOM2100VH • 125 A QOM2125VH • 150 A QOM2150VH • 175 A QOM2175VH • 200 A QOM2200VH

* Branch breakers must be series rated with SquareD QOM main breaker to achieve the 22 kA short-circuit current rating.



CAUTION: Use only appropriately sized, compatible circuit breakers according to the type of load. Ensure breaker selection is in accordance with NEC, CEC, and local code articles for any field modifications. Additional or replacement breakers should be of the same manufacturer, type designation, and equal or greater interrupting rating.

CAUTION: Refer to the specific breaker location instructions for each grid-forming hybrid inverter in the **Storage System Integration Manual**. Hybrid inverter breaker(s) must be connected to the position(s) indicated for the system to operate as intended.

Replacing the Main Breaker

- Remove the two (2) main breaker fastening nuts using a 7/16-inch hex socket.
- Remove the fastening screw using a #2 Philips bit.
- Slide the main breaker downwards and remove, then insert the new main breaker (see table above for acceptable models).
- Replace the fastening screw, torquing to 31 in-lbs (3.5 N-m).
- Replace the two (2) fastening nuts, torquing to 45 in-lbs (5.1 N-m) using a 7/16-inch hex socket.

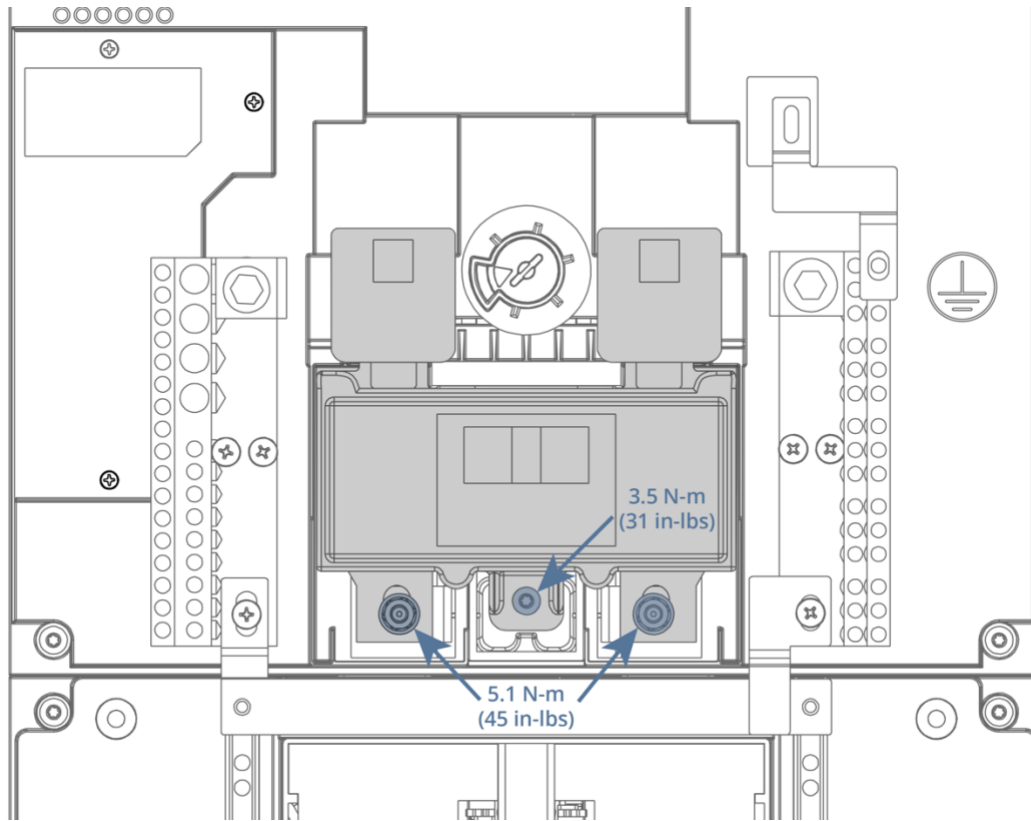

Fastener Locations for Replacing Main Breaker



CAUTION: Use a torque tool to avoid over-torquing the main breaker fasteners.

4. Wiring the Panel

Size all conductors with reference to the overcurrent protection device, ampacity, and voltage drop requirements in accordance with all local electrical codes. Use conductors rated to minimum of 75°C.

- Connect supply-side Line 1 and Line 2 conductors to the main breaker terminals.
- Connect supply Neutral and Ground conductors to their respective terminal blocks.
- Refer to the table below for suitable conductor gauges and torque requirements.
- Span sub-feed lugs are rated to 200A max.



WARNING: Risk of electric shock. Check that all circuits are de-energized before wiring including generation equipment such as solar inverters and storage batteries.



CAUTION: The Span Panel is only intended for use on 120/240 V split-phase electrical service.

- Connect Line conductors for all circuits to the respective breaker.
- Connect Neutral and Ground conductors to their respective wire terminals.
- Once all conductors are connected and secured, check that there are no exposed conductors or stray wires. Clean up conductor routing to ensure no wires will be pinched when re-assembling the autotransformer cabinet and deadfront assembly.



NOTE: Keep track of circuit labelling. This information will be required during commissioning.

Terminal Wire Gauge, Strip Lengths, and Torque Values

	Terminal name	Wire gauge (AWG)	Wire strip length	Tool	Torque value in-lbs (Nm)
A	Main Breaker	See instructions on breaker			
B	Main Neutral & Main GND terminal	#6 - 250 kcmil	1.25 in (32 mm)	3/8-in hex	250 - 275 (28.2 - 31.1)
C	Larger Neutral terminals	#14 - 1/0	0.75 in (20 mm)	5 mm slotted	35 (4.0) for #14-10 40 (4.5) for #8 45 (5.1) for #6-4 50 (5.6) for #3-1/0
D	Smaller Neutral terminals & GND terminal block	#14 - 4	0.5 in (12 mm)	5 mm slotted	20 (2.3) for #14-10 25 (2.8) for #8 35 (4.0) for #6-4
E	Feed-through lugs (L1/L2)	#6 - 250 kcmil	1.25 in (32 mm)	5/16-in hex	250 - 275 (28.2 - 31.1)



NOTE: Torque circuit breaker terminals to values specified on the breakers.

NOTE: Terminals other than breaker terminals suitable for 60/75°C AL/CU wire. Breaker terminals suitable for wire as marked.

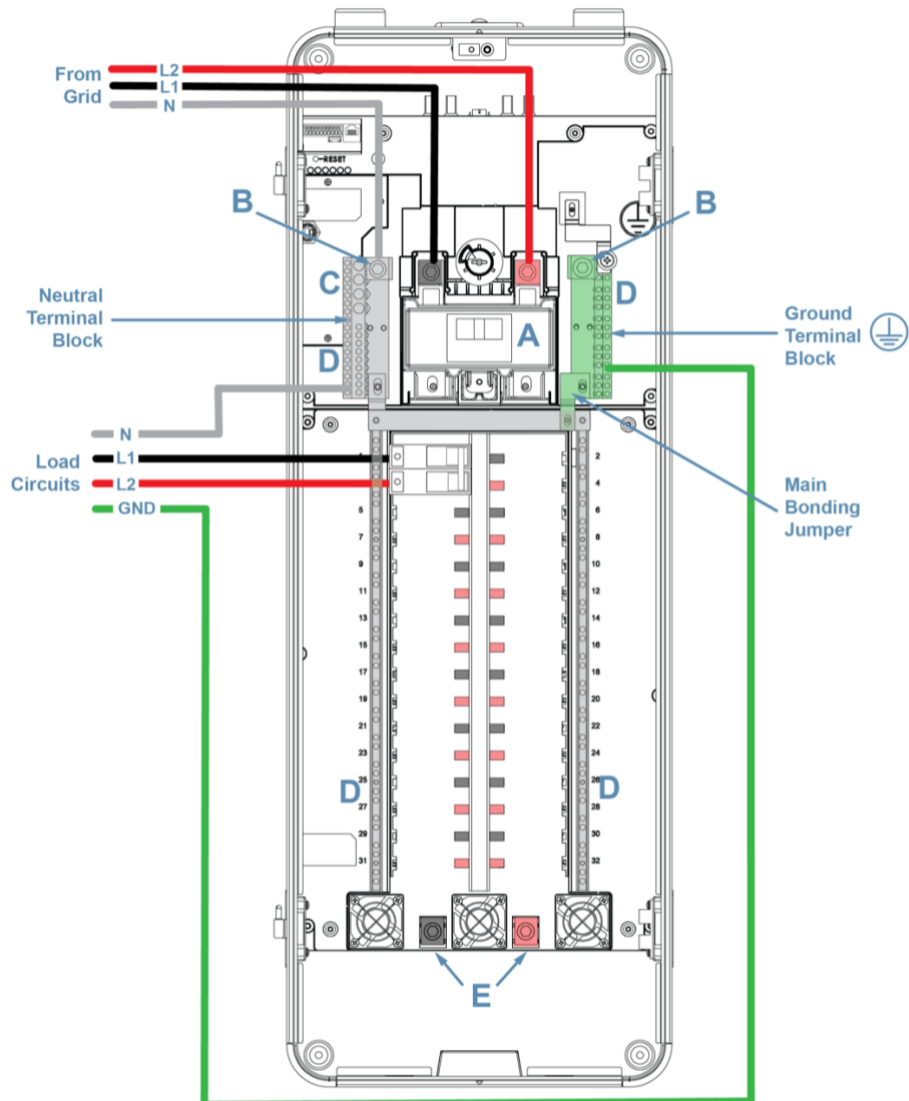

Span Panel AC Wiring

5. Communication Wiring

- Use minimum 300 V rated, shielded, twisted-pair, copper conductors only for communication wiring.
- Connecting the Span Panel to the Internet with a wired Ethernet is strongly recommended.

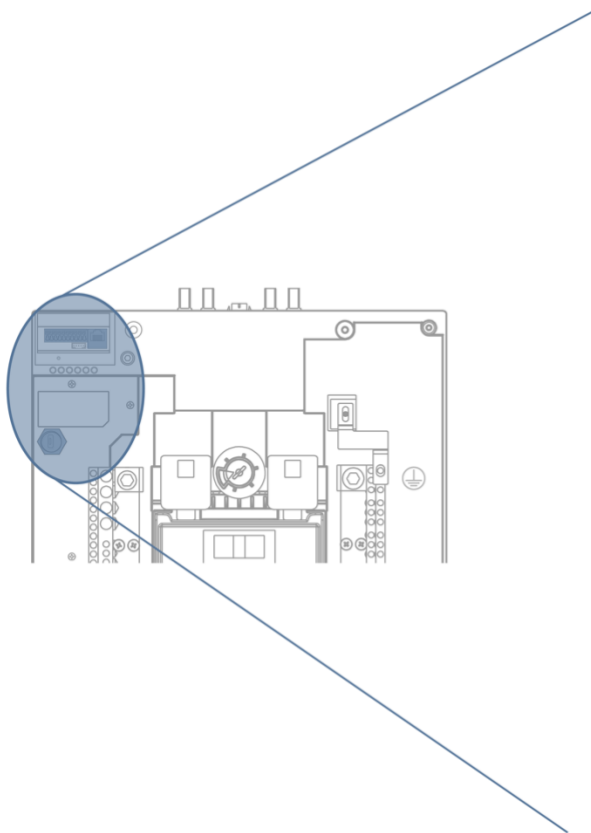

RS-485

24–16 AWG
Strip 0.28 in (7 mm)
Max 328 ft (100 m)

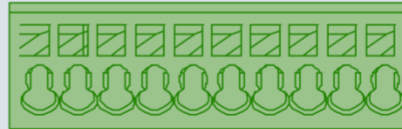

1 2 3 4 5 6 7 8 9 10
| | | | | | | | | |
1+ 1- G 2+ 2- G 3+ 3- G
not used

Ethernet

CAT5 / CAT6
Max 328 ft (100 m)

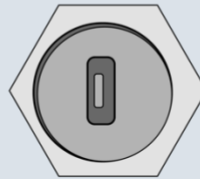
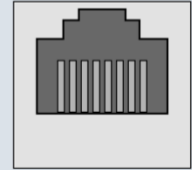

Aux Comms

for micro-USB to RJ45 dongle



NOTE: To insert wiring into RS485 terminal, use a 2mm flat head driver to depress the tab while inserting stripped wire.

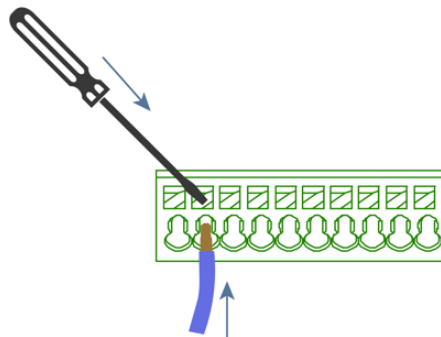

6. Configuring the Door Swing Direction

To configure the door to open from the other direction:

- Using a #2 Philips driver, remove the 2 hinge brackets and 2 latch brackets from the enclosure.
- Re-install the hinge and latch brackets on the desired side, tightening each screw (2 per bracket) and torque to 26.5 in-lbs (3 Nm).
- On the inside of the door, remove and swap the mating hinge and latch hardware, and re-install and torque to 26.5 in-lbs (3 Nm).

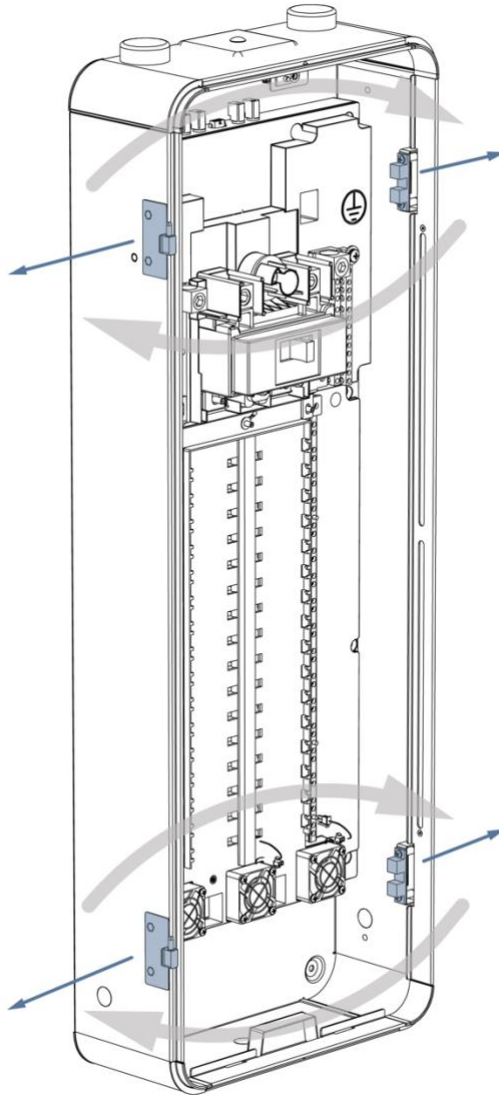

Swapping Door Mounting Hardware

7. Installing the Flush Mount Trim Kit

The Flush Mount Trim Kit (PN: 1-01046) is used for indoor installations to easily cover square holes cut into the wall during installation. The overall dimensions when mounted are 1123 x 405 mm (44.2 x 15.9 in).

- Place the two (2) metal Trim Mounting Brackets directly against the Span Panel's top and bottom faces, using the triangular decals to center.
- Affix the upper and lower Trim Mounting Brackets to the wall or stud using four (4) mounting screws.
- Snap the Trim Piece in place, ensuring all four mounting sockets are fully engaged.

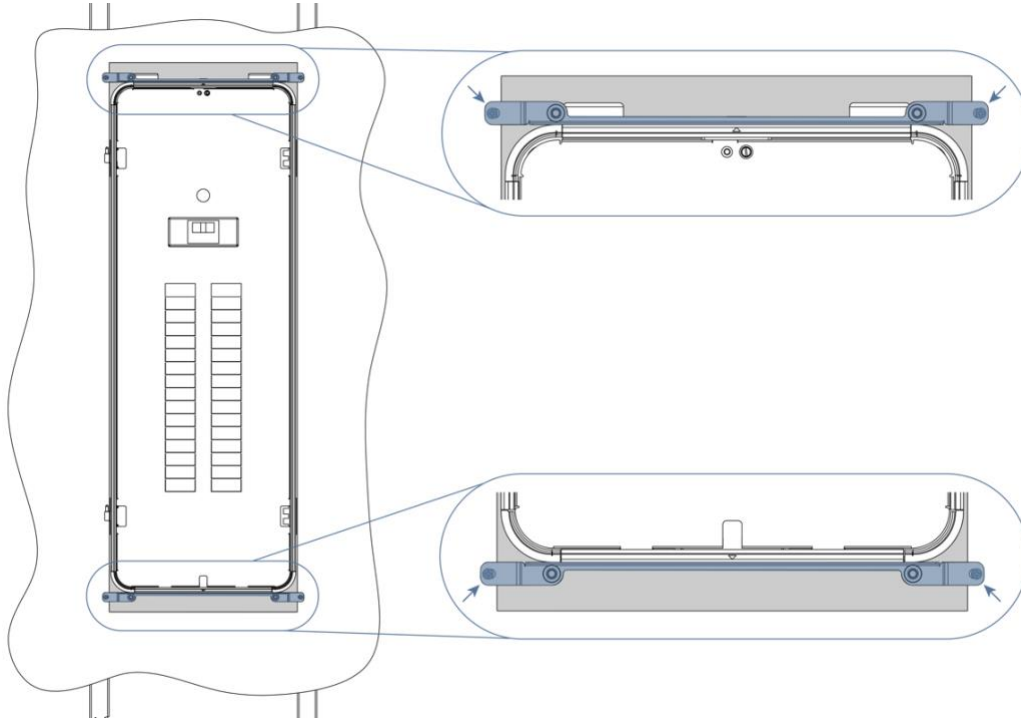

Installing Trim Mounting Brackets

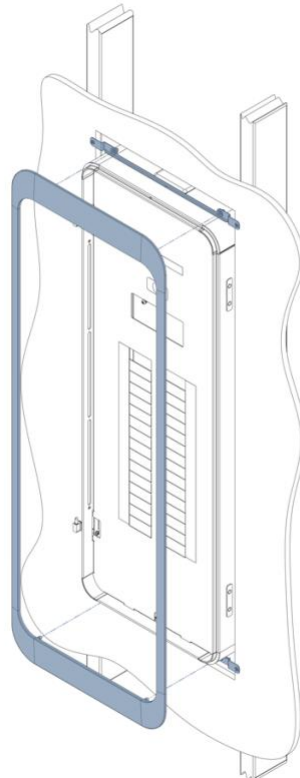

Snapping Trim Piece in Place

8. Final Inspection and Closing the Unit

- Confirm that all connections are correct, properly grounded, and secure.
- Replace the deadfront and securing using the flathead screw.
- Install the door by sliding down onto the hinges.
- Only after fully replacing the deadfront assembly, restore power.
- Lock the panel closed with the hasp at the bottom of the panel door using a lock provided by the homeowner.



WARNING: Risk of electric shock. Do not modify the deadfront other than to configure the door hinges or to remove or replace breaker filler plates, as needed.

9. Commissioning

The Panel must be configured with the **Span Installer App** prior to use.

Download the **Span Installer App** from www.span.io/span-apps

Follow the on-screen instructions. When prompted to connect to the panel, refer to the panel Serial Number located on the product label inside of the door.



NOTE: When Span's relays open/close they will sound like a digital camera taking a photo. When Span transitions on- or off-grid, several relays may open/close at once which sounds like a digital camera taking multiple photos. This is normal.

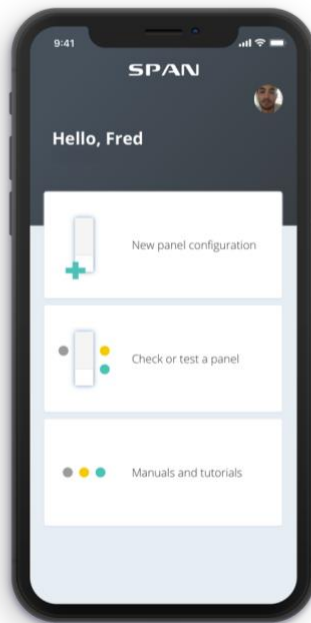

Span Installer App home screen

TROUBLESHOOTING & SERVICING

For additional troubleshooting and support visit www.support.span.io

Communication with the Span Panel

Follow these troubleshooting steps to establish communication and verify operation of the Span Installer App:





- Wait at least 3 minutes after powering on before attempting to connect to the Panel.
- Ensure the panel is connected to the internet, using the Installer App.
- Ensure the battery backup system is communicating with the Span Panel using the Installer App.
- Ensure all circuits and circuit locations are correctly identified in the Installer App.
- To restart the system, press and hold the Reset button for 10 seconds (see “Resetting the System” below).

For further assistance, contact support@span.io.



WARNING: Do not attempt to open, disassemble, repair, tamper with, or modify the equipment. The equipment contains no user-serviceable parts other than field-installed breakers. Contact the installer who installed the equipment for any repairs. Only qualified electrical personnel should remove the deadfront panel.

Status LEDs

Indication	Label	LED Color	LED State	Note
Main Power		Green	Solid	Main PCBA powered
		Off	Off	No AC power to panel
Warning		Green	Solid	Fault: Hybrid inverter and/or autotransformer automatically disconnected from main bussing.
		Off	Off	Normal operation
Grid Status		Green	Solid	Grid voltage detected
		Off	Off	Grid voltage not detected
Gateway Power		Green	Solid	Gateway PCBA powered
		Off	Off	No power to Gateway PCBA
(Future Use)	X	--	--	--
(Future Use)	Y	--	--	--

Resetting the System

If it becomes necessary to restart the system use a small tool to press the Reset button, located below the communication terminals. **Hold the button for 10 full seconds before releasing.**

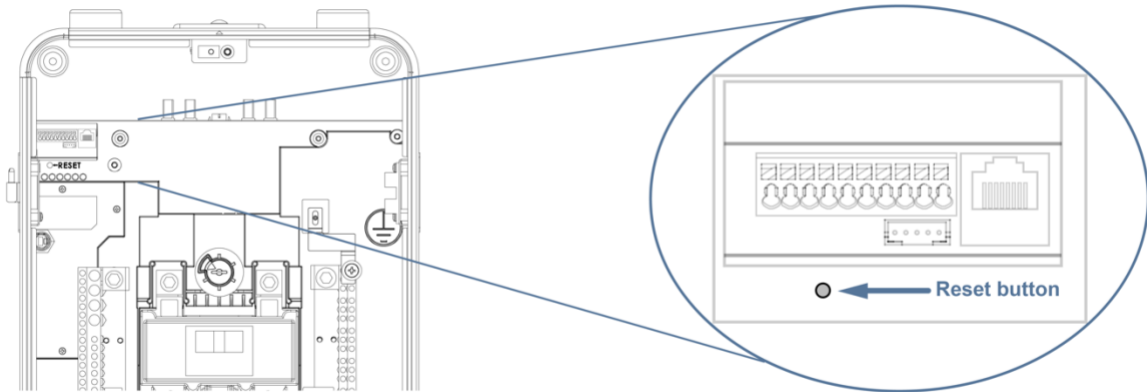

Overriding the Grid Disconnect Relay

If it is necessary to manually reconnect your home to the grid, Span Support may direct you to operate the manual override in the Span Panel.

- To reconnect to the grid manually, peel away the protective label, insert a large flathead screwdriver, and turn **counterclockwise** until you hear a click.



CAUTION: Do not remove the protective label or operate the manual override unless directed to do so by Span Support. Improper operation of the manual override may damage the unit.

Adding, Removing, or Changing Branch Circuit Breakers

Branch circuit position numbers are labelled adjacent to the breaker. A specific space location can be associated with the physical circuit position in the Span panel by viewing the space in either the Span Installer or Span Home app.

To add, remove, or change branch circuit breakers:

- Follow instructions above in this manual to select, install, and wire circuit breakers.
- Use the Span Installer app to make changes to the branch breakers, following on screen instructions.

Homeowners should be instructed to contact Span Support for any future branch breaker additions, removals, or changes.



CAUTION: To perform routine service or maintenance on circuits, confirm that the corresponding circuit breakers are switched off. Powering down circuits using the Span internal relays should not be considered a suitable Off position for servicing equipment.

APPENDIX A: CIRCUIT BREAKER COMPATIBILITY

Span has been evaluated per the UL Standard for Panelboards for use with the branch breaker types below.

Informational notes:

- National Electric Code (NFPA 70) does not prohibit the use of different branch circuit breakers in panelboards provided it does not violate the listing of any equipment. NEC article 110.3(B) states *"Equipment that is listed, labeled, or both shall be installed and used in accordance with any instructions included in the listing or labeling."*
- The standard for Molded-Case Circuit Breakers (UL 489) does not require listing circuit breakers for use in specific panel, nor does this standard cover panelboards. Such testing is covered by the UL standard for Panelboards (UL 67), which does require the panelboard to be listed with specific breaker types. Span is certified to the UL 67 standard via a Nationally Recognized Testing Lab (NRTL) for use with the branch circuit breakers below. This is reflected in this Installation information as well as marked on the product itself.

For additional information visit www.support.span.io

The Span Panel is compatible with the following Homeline circuit breakers from Square D:

- General circuit breakers type HOM; 1-pole and 2-pole; rated 10-90 amperes; catalog numbers HOM followed by 110 to 290.
- Tandem circuit breakers type HOMT; 1-pole; rated 10-30 amperes; catalog numbers HOMT followed by 1010 to 3020.
- Quad tandem circuit breakers type HOMT; 1-pole and 2-pole; rated 15-50 amperes; catalog numbers HOMT followed by 1515215 to 2020250.
- Quad tandem circuit breakers type HOMT; 2-pole; rated 15-50 amperes; catalog numbers HOMT followed by 215215 to 230250.
- Combination arc fault circuit interrupter circuit breakers type HOM-CAFI; 1-pole and 2-pole; rated 10-20 amperes; with or without plug-on neutral feature; catalog numbers HOM followed by 110 to 220; may be followed by P; followed by CAFI.
- Ground fault circuit interrupter circuit breakers type HOM-GFI; 1-pole and 2-pole; rated 10-50 amperes; with or without plug-on neutral feature; catalog numbers HOM followed by 110 to 250; may be followed by P; followed by GFI.
- Ground fault equipment protection circuit breakers type HOM-EPD; 1-pole and 2-pole; rated 15-50 amperes; catalog numbers HOM followed by 115 to 250; followed by EPD.
- Dual function combination ground fault and arc-fault protection circuit breakers type HOM-DF; 1-pole; rated 10-20 amperes; with or without plug-on neutral feature; catalog numbers HOM followed by 110 to 120; may be followed by P; followed by DF.

The Span Panel is compatible with the following circuit breakers from Eaton:

- General circuit breakers type BR; 1-pole and 2-pole; rated 10-90 amperes; catalog numbers BR or BRH; followed by 110 to 290.
- Duplex (tandem) circuit breakers type BD; 1-pole; rated 10-50 amperes; catalog numbers BD followed by 1010 to 5050.
- Quadplex (tandem) circuit breakers type BQ and BQC; 1-pole and 2-pole; rated 15-50 amperes; catalog numbers BQ followed by 215215 to 2502120.
- Combination arc fault circuit interrupter circuit breakers type BR; 1-pole and 2-pole; rated 10-20 amperes; catalog numbers BRC, BRN or BRL followed by 110 to 120; followed by AF or CAF.
- Ground fault circuit interrupter circuit breakers type GFTCB and GFEP; 1-pole and 2-pole; rated 10-60 amperes; catalog numbers BRN, GFTCB, BRHN, or GFTCBH followed by 110 to 260; may be followed by GF.
- Ground fault equipment protection circuit breakers type GFEP; 1-pole and 2-pole; rated 15-50 amperes; catalog numbers BRN or GFEP followed by 115 to 250; may be followed by EP.
- Dual function combination ground fault and arc-fault protection circuit breakers type BR; 1-pole; rated 10-20 amperes; catalog numbers BRN or BRAFGF followed by 110 to 120; may be followed by DF.

The Span Panel is compatible with the following circuit breakers from Siemens:

- General circuit breakers type QP; 1-pole and 2-pole; rated 10-90 amperes; catalog numbers Q followed by 110 to 290; may be followed by H.
- Duplex (tandem) circuit breakers type QT; 1-pole; rated 10-30 amperes; catalog numbers Q followed by 1010 to 3030 may be followed by NC.
- Triplex (tandem) circuit breakers type QT; 1-pole and 2-pole; rated 10-30 amperes; catalog numbers Q followed by 21010 to 23030; followed by CT.
- Quadplex (tandem) circuit breakers type QT; 2-pole; rated 15-40 amperes; catalog numbers Q followed by 21515 to 24040; followed by CT2.

- Branch-feeder arc fault circuit interrupter circuit breakers type QAF2; 1-pole and 2-pole; rated 15-20 amperes; catalog numbers QA followed by 115 to 120; followed by AF; may be followed by H.
- Combination arc fault circuit interrupter circuit breakers type QAF and QAF2; 1-pole and 2-pole; rated 10-20 amperes; catalog numbers Q or QA followed by 110 to 220; followed by AFC; may be followed by H.
- Tandem combination arc-fault circuit interrupter circuit breakers type CAFCI; 1-pole; rated 10-20 amperes; catalog numbers Q followed by 1010 to 2020; followed by AFC.
- Ground fault circuit interrupter circuit breakers type QPF and QPF2; 1-pole and 2-pole; rated 10-60 amperes; catalog numbers QF followed by 110 to 260; followed by A; may be followed by H.
- Ground fault equipment protection circuit breakers type QE; 1-pole and 2-pole; rated 15-60 amperes; catalog numbers QE followed by 115 to 260; may be followed by H.
- Dual function combination ground fault and arc-fault protection circuit breakers type QFGA2; 1-pole; rated 10-20 amperes; catalog numbers Q followed by 110 to 120; followed by DF; may be followed by H.

The Span Panel is compatible with the following MP circuit breakers from Murray:

- General circuit breakers type MP-T; 1-pole and 2-pole; rated 10-90 amperes; catalog numbers MP or MPH followed by 110 to 290; may be followed by KH.
- Duplex (tandem) circuit breakers type MH-T; 1-pole; rated 10-30 amperes; catalog numbers MP followed by 1010 to 3030; may be followed by N.
- Triplex (tandem) circuit breakers type MH-T; 1-pole and 2-pole; rated 10-30 amperes; catalog numbers MP followed by 21010 to 25020.
- Quadplex (tandem) circuit breakers type MH-T; 2-pole; rated 15-40 amperes; catalog numbers MP followed by 21515 to 24040; followed by CT2.
- Branch-feeder arc fault circuit interrupter circuit breakers type MP-AT2; 1-pole and 2-pole; rated 15-20 amperes; catalog numbers MPA followed by 115 to 120; followed by AF; may be followed by H.
- Combination arc fault circuit interrupter circuit breakers type MP-AT2; 1-pole and 2-pole; rated 10-20 amperes; catalog numbers MP or MPA followed by 110 to 220; followed by AFC; may be followed by H.
- Ground fault circuit interrupter circuit breakers type MP-GT; 1-pole and 2-pole; rated 10-60 amperes; catalog numbers MP followed by 110 to 260; followed by GFA; may be followed by H.
- Ground fault equipment protection circuit breakers type MP-ET; 1-pole and 2-pole; rated 15-60 amperes; catalog numbers MP followed by 115 to 260; followed by EG; may be followed by H.
- Dual function combination ground fault and arc-fault protection circuit breakers type MP-GAT2; 1-pole; rated 10-20 amperes; catalog numbers MP followed by 110 to 120; followed by DF; may be followed by H.

APPENDIX B: SURGE PROTECTIVE DEVICE COMPATABILITY

Per 2020 NEC 230.67 Surge Protection

- A surge protective device (SPD) shall be installed in all new and replacement services supplying dwelling units.
- Shall be Type 1 or Type 2 SPD.
- Shall be attached to the service equipment or immediately adjacent. *Exception:* The SPD shall not be required to be in the service equipment if located at each next level distribution equipment downstream toward the load.

Span is compatible with virtually any standard SPD connected to a 2-pole breaker or installed on a 2-space slot in equivalent Squared HOM, Eaton BR, or Siemens/Murray QP/MP panelboards.

- When installing an SPD, mark it as an essential circuit in the Span Installer App under Advanced settings, depicted below.
- If using an SPD with usable circuits, be sure to only have essential items on those circuits (e.g., internet router, alarms, fire detection). Homeowners will not be able to turn this circuit off via the Span Home app.

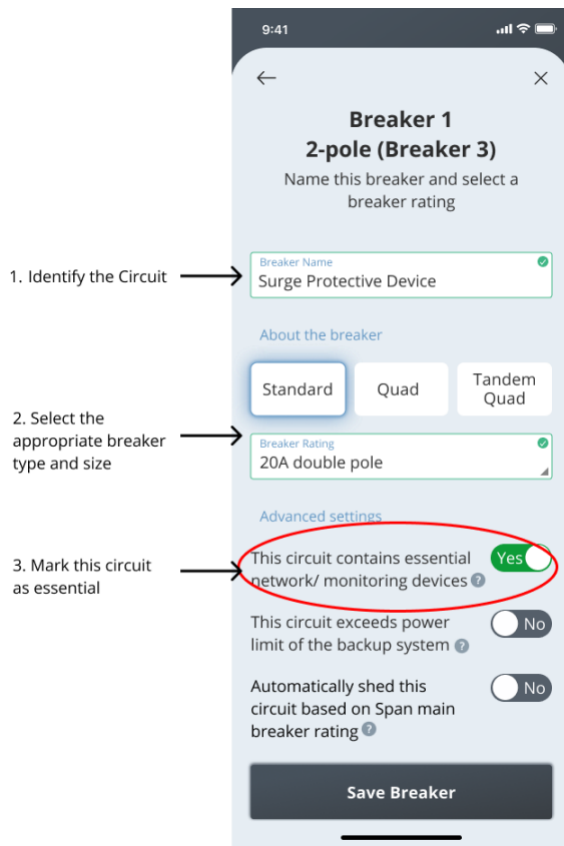

When using an SPD with usable circuits, the two circuits should be used for something essential (e.g. internet router, alarms, fire detection, etc.). Homeowners will not be able to turn this circuit off via the Span Home App

Setting to follow when using an SPD in Span

Revision Log

Version	Note
2021-05-15	<ul style="list-style-type: none">• First revision
2021-06-04	<ul style="list-style-type: none">• Corrected product weight in spec table• Added Networking Kit and Trim Kit to accessory list• Added Servicing instructions regarding breaker replacement or additions
2021-06-21	<ul style="list-style-type: none">• Added main breaker replacement details• Added Flush Mount Trim Kit installation instructions
2021-06-29	<ul style="list-style-type: none">• Added dimensions for Flush Mount Trim Kit
2021-12-04	<ul style="list-style-type: none">• Added Appendix A: Circuit Breaker Compatibility
2022-01-21	<ul style="list-style-type: none">• Added Appendix B: Surge Protective Device Compatibility• Updated figure in Install Conduit section to include Conduit Entry Location dimensions• Updated Wiring the Panel section to include sub-feed lug rating
2022-01-28	<ul style="list-style-type: none">• Updated image and information under section "Dimensions, Clearances, and Access"• Minor updates to "Preparing to Install" section