



# Three Phase Inverter with Synergy Technology

Quick Installation Guide

PN: SExxK-xxxxlxxxx

For North America  
Version 1.6

Scan for full  
installation guide



# Legend

## NOTE

This symbol denotes information intended to assist the user in making optimum use of the product.

## CAUTION!

Denotes a hazard. It calls attention to a procedure that, if not correctly performed or adhered to, could result in damage or destruction of the product. Do not proceed beyond a caution sign until the indicated conditions are fully understood and met.

## WARNING!

Denotes a hazard. It calls attention to a procedure that, if not correctly performed or adhered to, could result in injury or loss of life. Do not proceed beyond a warning note until the indicated conditions are fully understood and met.



Do not cut the cable connectors



This symbol appears at grounding points on the SolarEdge manuals and equipment.

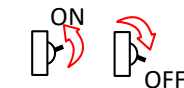

Turn ON/OFF the main circuit board AC switch. When turning off, wait 5 minutes for DC Voltage to drop to safe level before removing the front panel.



Turn the DC Disconnect Switch on/off. When turning off, wait 5 minutes for DC Voltage to drop to safe level before removing the front panel.

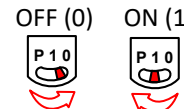

Turn the ON/OFF/P Switch on/off. When turning off, wait 5 minutes for DC Voltage to drop to safe level before removing the front panel.



Before connecting aluminum wires to terminals:

1. Remove oxide from the exposed wires with emery paper or a steel wire brush
2. Clean dust with a cloth and Isopropyl alcohol (IPA)
3. Coat wires with a designated antioxidant aluminum wire grease immediately after cleaning



**CAUTION!** Connection of oxidize aluminum wires may result in resistance and high temperatures at contact points. Improper execution of the following procedure may cause damage to the unit.

**SAVE THESE INSTRUCTIONS** – This manual contains important instructions for the Three Phase Inverter with Synergy Technology that should be followed during installation and maintenance. Using this equipment in a manner not specified in this guide by SolarEdge may impair the protection provided by this equipment.



**WARNING!** Upon servicing or replacing equipment, instructions in the installation manual must be followed to maintain the integrity of the PV hazard control system. SolarEdge commercial optimizers and three phase inverters should only be replaced with SolarEdge commercial optimizers and inverters. Third party equipment is not compatible.



**WARNING!** SYNERGY UNIT, PN: SESUK-USRxxxx, INCLUDE A PHOTOVOLTAIC RAPID SHUTDOWN SYSTEM (PVRSS). SUCH UNITS, INCORPORATE ONE OR MORE PIECES OF EQUIPMENT THAT EXERCISE THE RAPID SHUTDOWN CONTROL OF PV SYSTEM CONDUCTORS REQUIRED BY SECTION 690.12 OF THE NEC (NFPA 70). OTHER EQUIPMENT INSTALLED IN OR ON THIS PV SYSTEM MAY ADVERSELY AFFECT THE OPERATION OF THIS PVRSS. IT IS THE RESPONSIBILITY OF THE INSTALLER TO ENSURE THAT THE COMPLETED PV SYSTEM MEETS THE APPLICABLE RAPID SHUT DOWN FUNCTIONAL REQUIREMENTS. THIS EQUIPMENT MUST BE INSTALLED ACCORDING TO THE MANUFACTURER'S INSTALLATION INSTRUCTIONS



# Installing the Power Optimizers

1

1 2 3 4 5 6

1

Use SolarEdge Designer  
to design SE system  
<https://designer.solaredge.com>

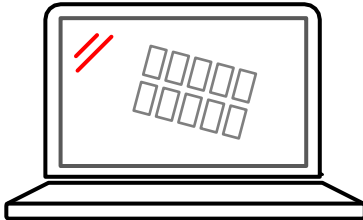

2

Download SolarEdge Mapper to  
map string Power Optimizers

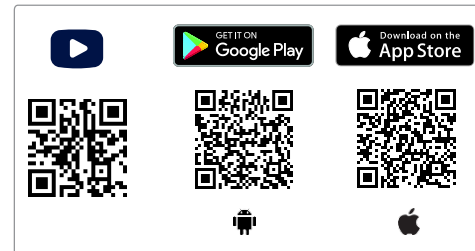

## 1

## Installing the Power Optimizers

1 2 3 4 5 6

3

Scan QR code using Mapper

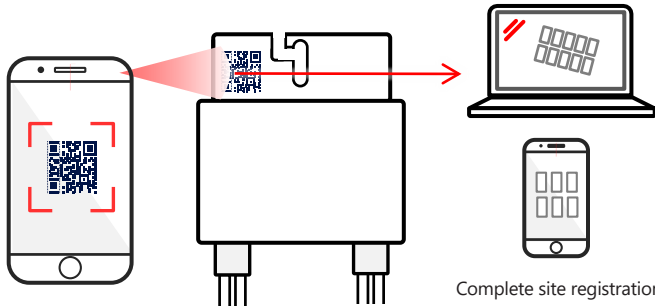

4

Install Power Optimizer

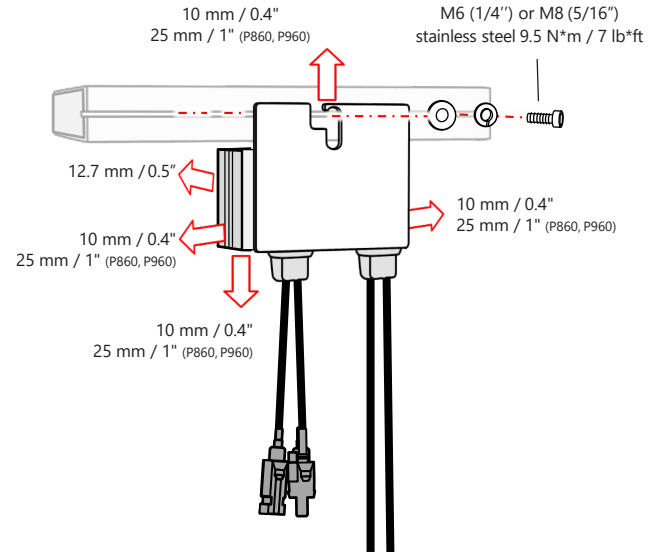

# Installing the Power Optimizers

# 1

1 2 3 4 5 6

5 Connect input from Module

6 Connect output to String

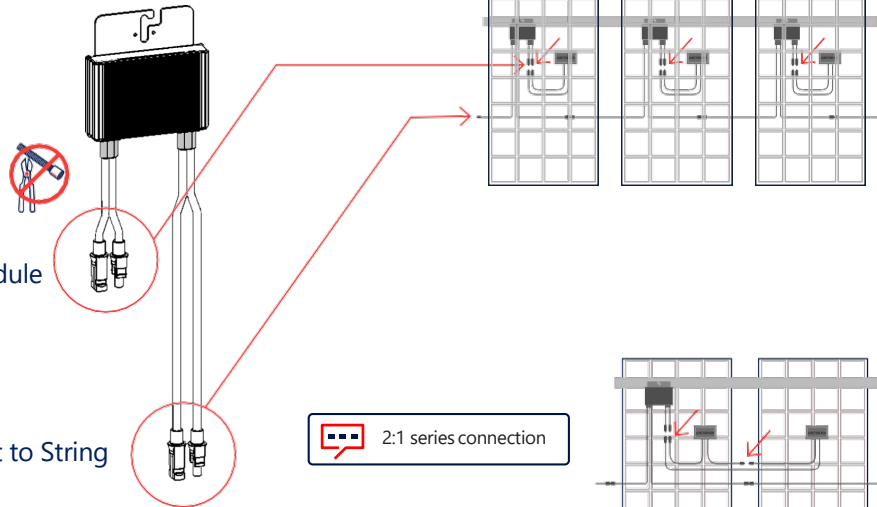

2:1 series connection

Use a dual input optimizer (P800p) for parallel connection of two PVs or use a branch cable to connect two PVs to a single input optimizer.

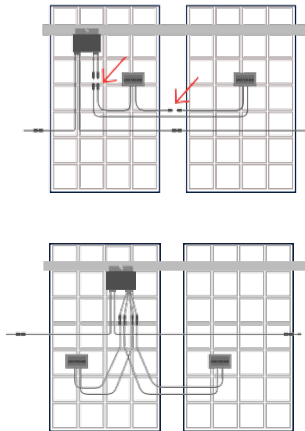

## 2

## Connecting the PV Array

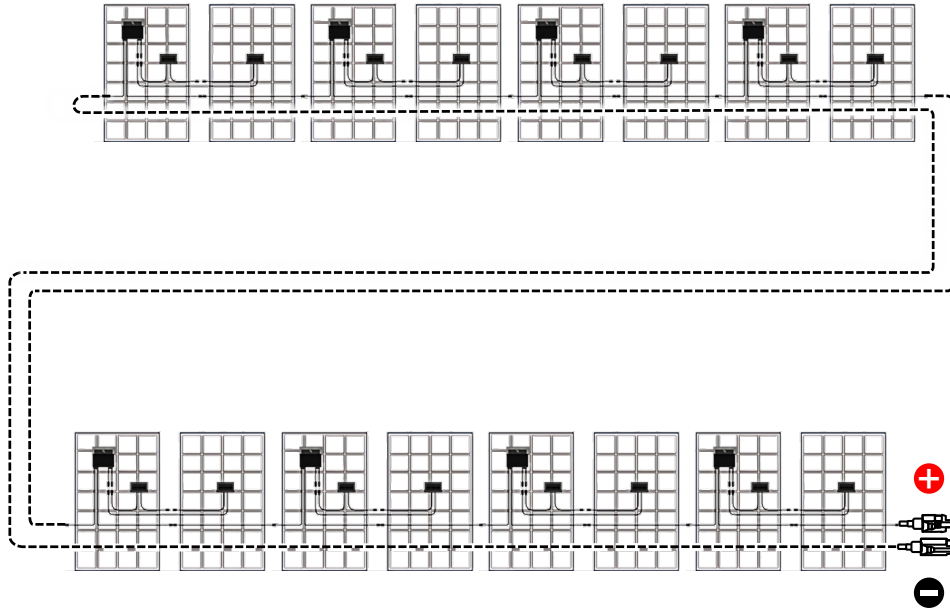
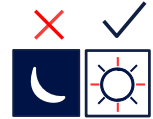

Check array polarity.  
Verify  $1 \pm 0.1V$  per optimizer  
Example: 8 optimizers =  $\sim 8V$

# Maintaining Clearance

# 3

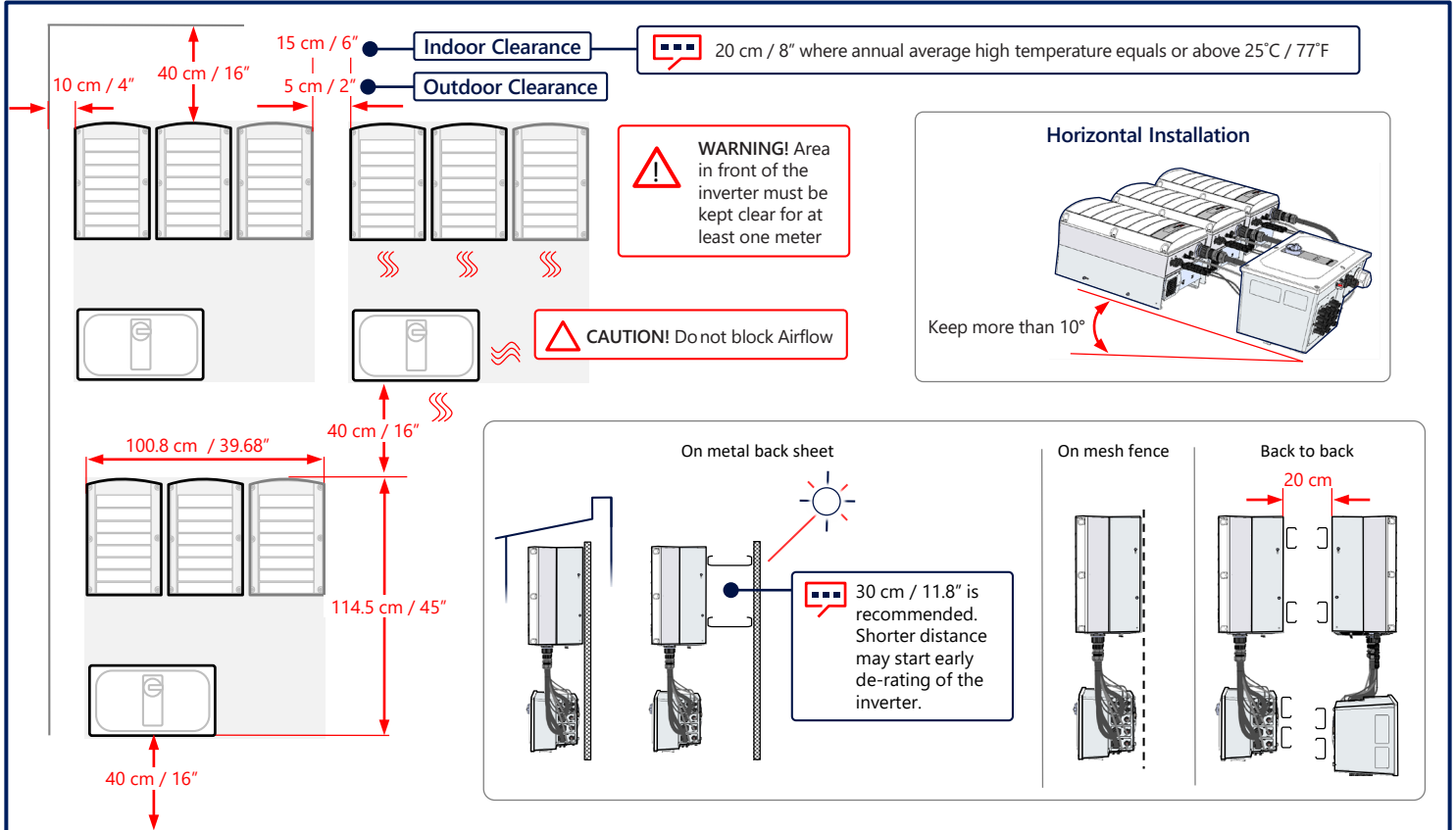



# 4 Marking & Drilling Holes

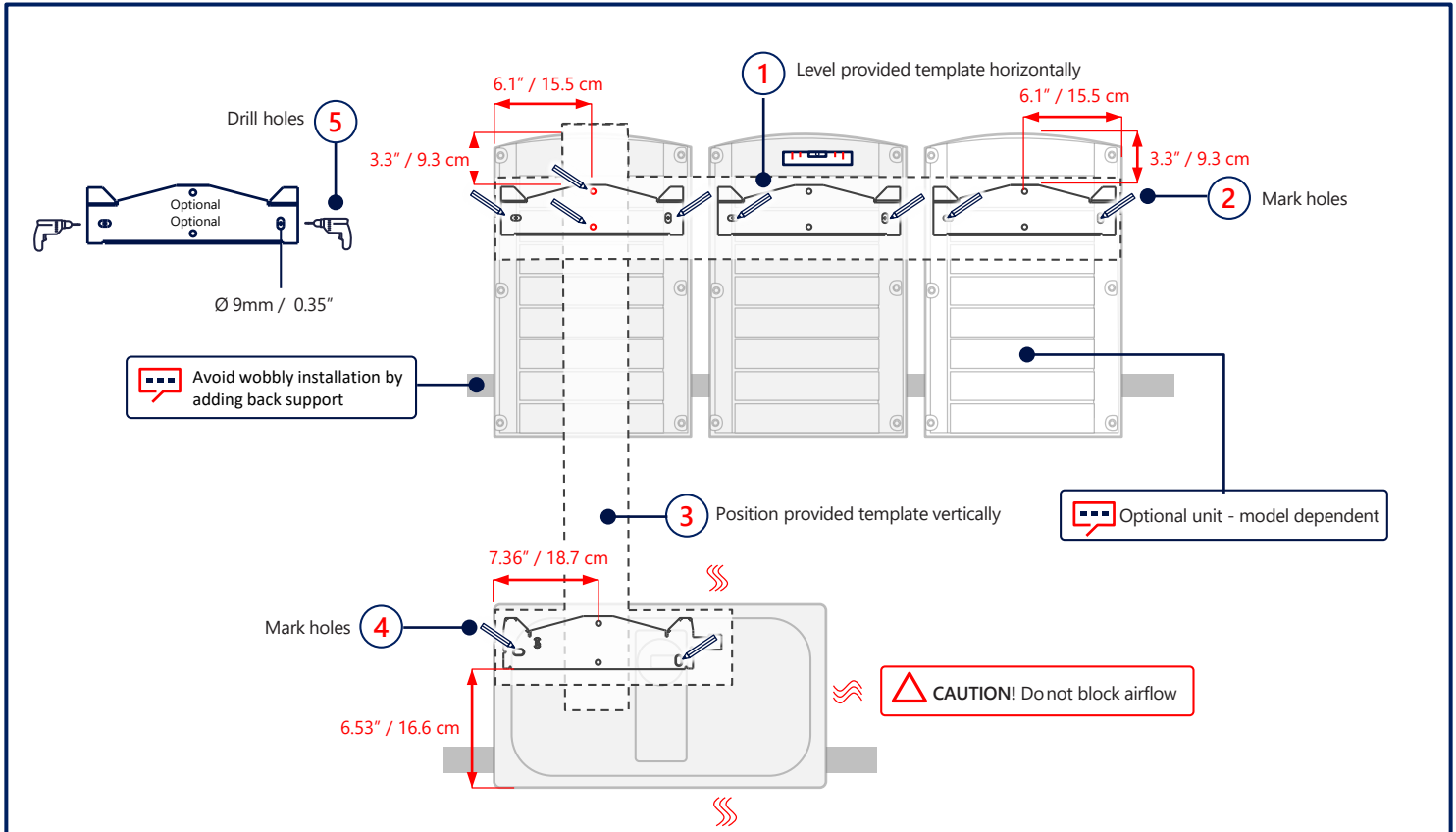

## Mounting the Units

## 5

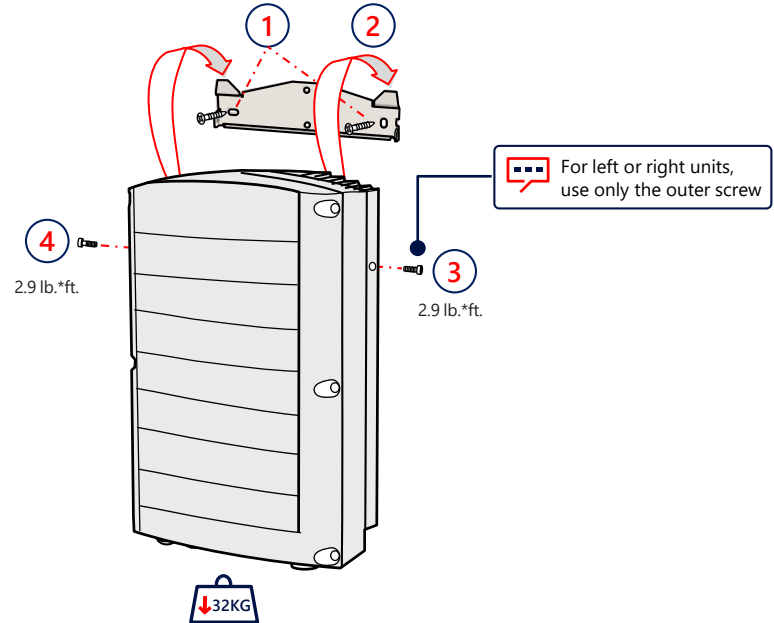
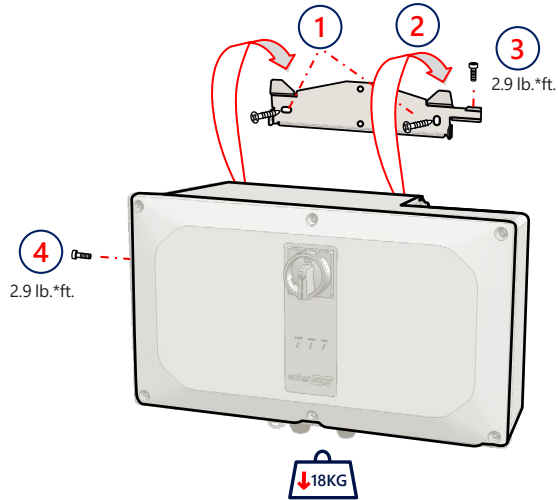

# 6 Connecting Cables

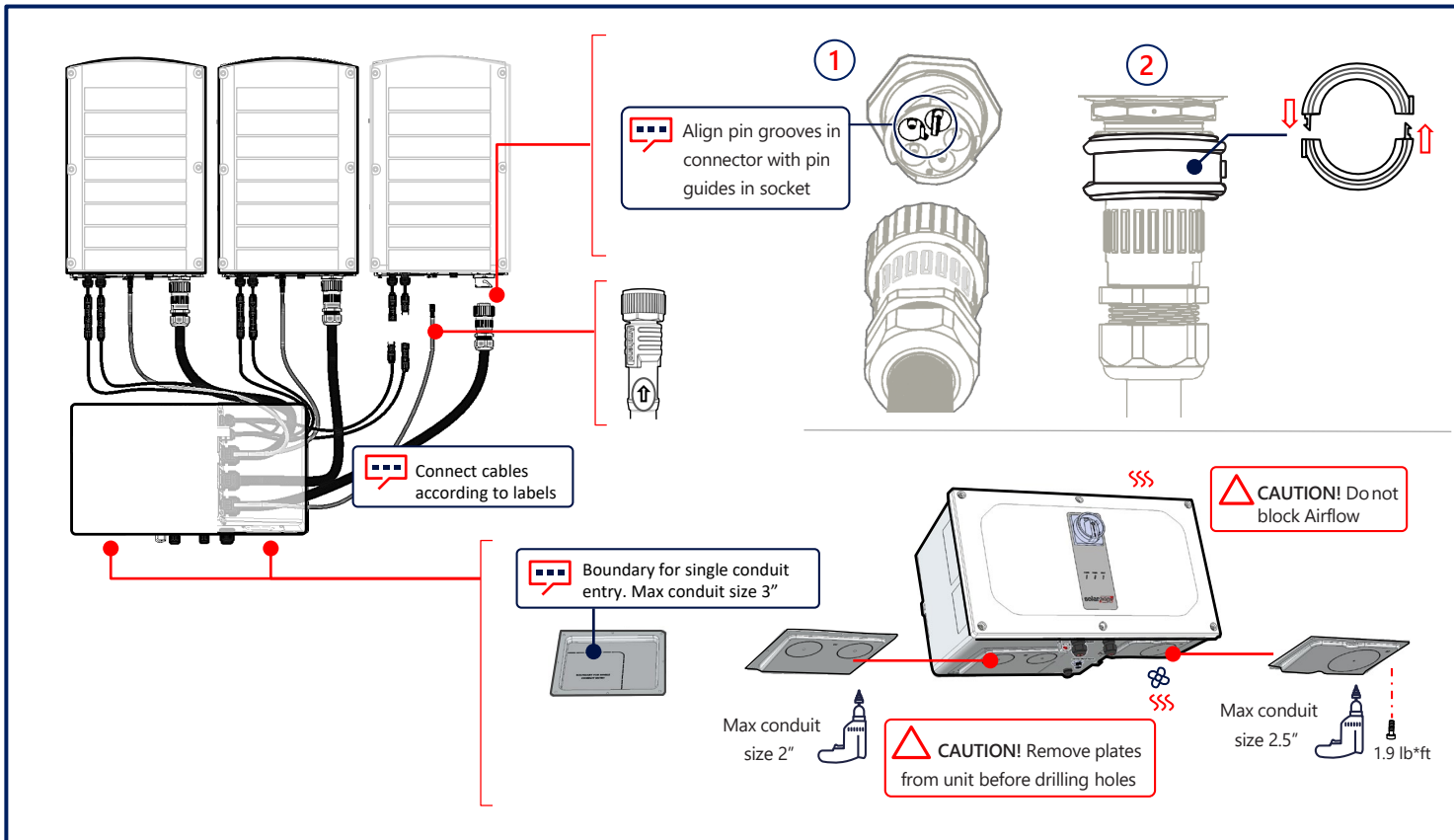

# Removing Covers

# 7

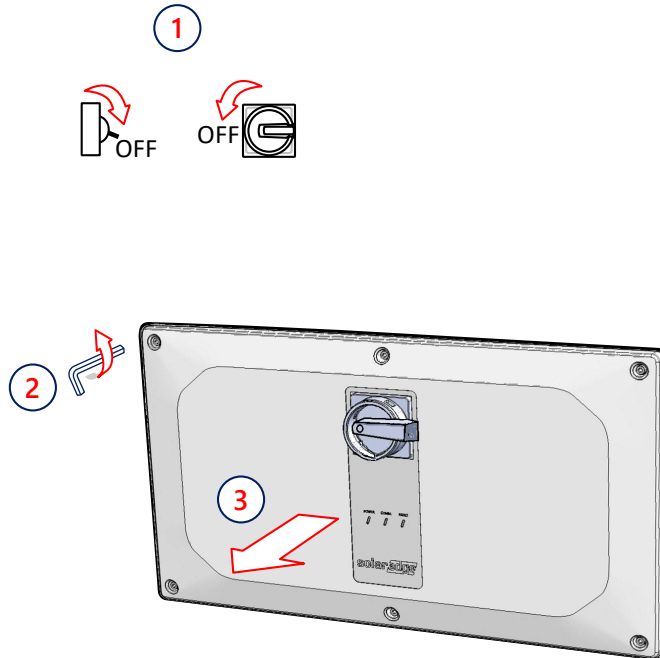

**WARNING**

DISCONNECT POWER BEFORE BEGINNING INSTALLATION

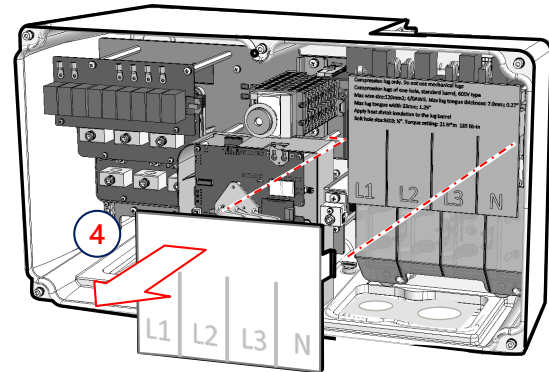

## 8

## Connecting PV Strings (Option 1)

When using a stranded wire, use of ferrule is at the installer discretion

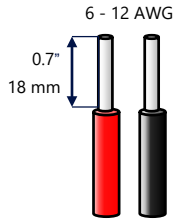

Ground conduit nut if required by regulation

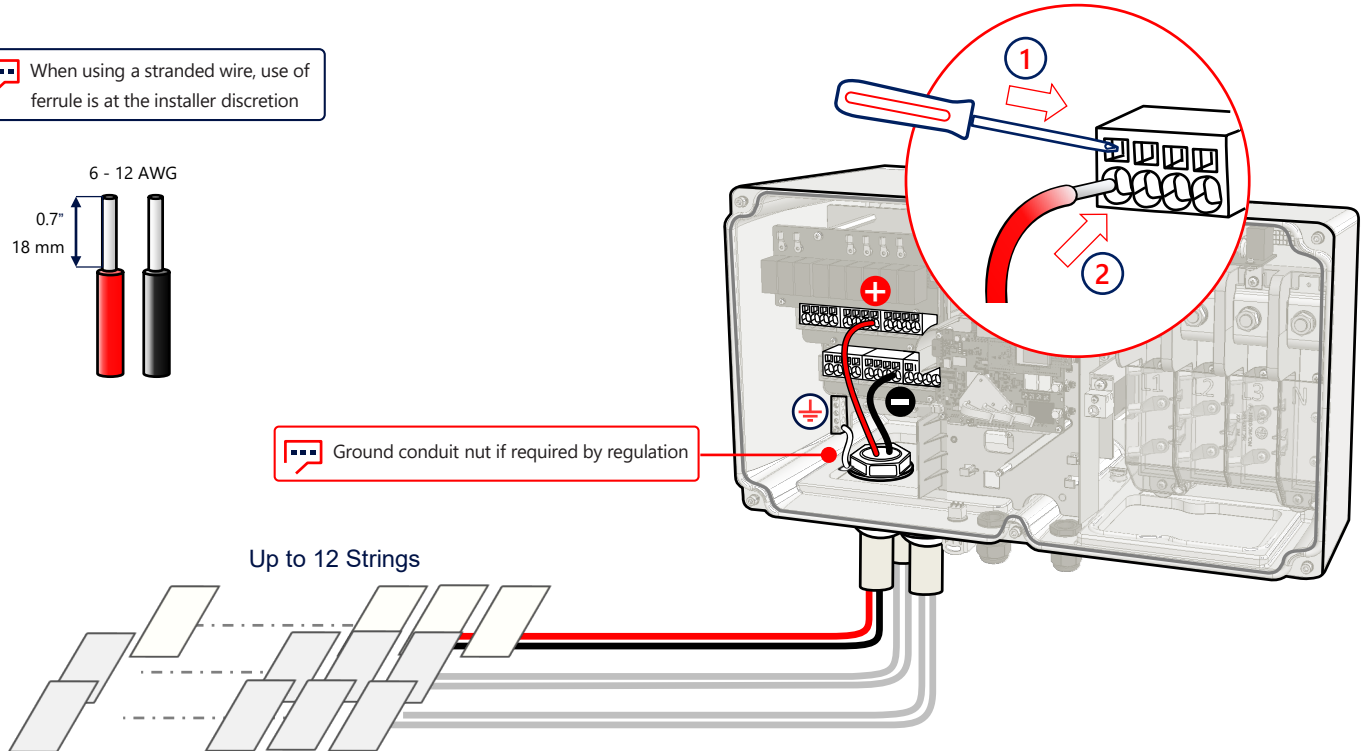

# Connecting PV Strings (Option 2)

Synergy Units

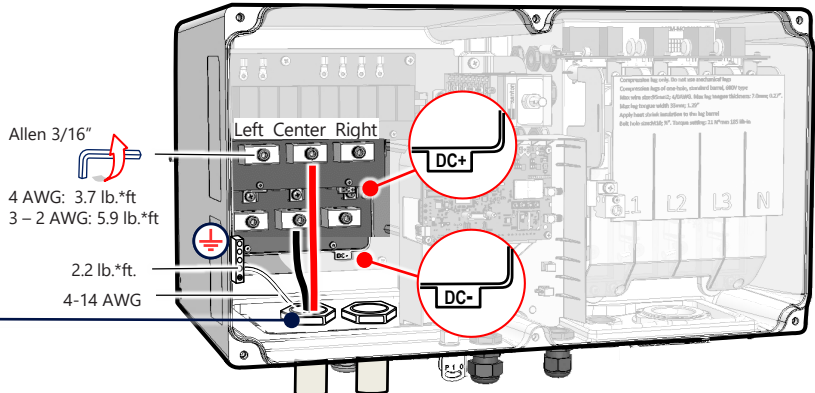

Ground conduit nut if required by regulation

Ferrule →



Fine stranded wire →

Use 90°C copper or aluminum wire

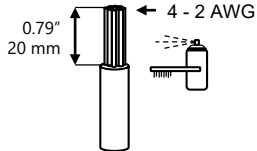

**Important:** When installing a system with more than 3 strings per a single Synergy Unit (whether connected directly or via a combiner box), fuses are required. In SolarEdge system, 25A fuses shall be used

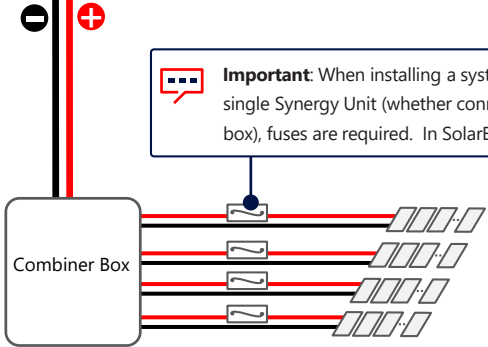

## 9

## Connecting AC and Protective Earth

☰ The inverter can either support 4 wire + PE or 3 wire + PE connection

☰ Overcurrent protection for the AC output must be provided by others, see manual for guidance

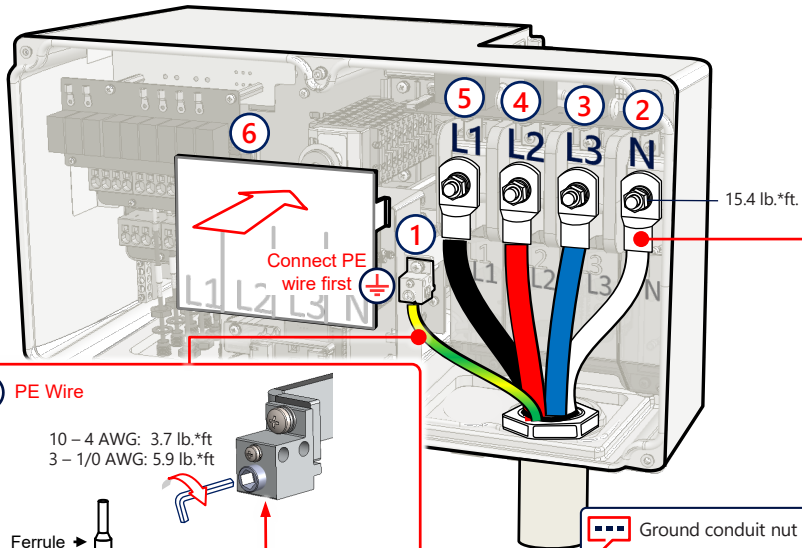

### PE Wire

10 - 4 AWG: 3.7 lb.\*ft.  
3 - 1/0 AWG: 5.9 lb.\*ft

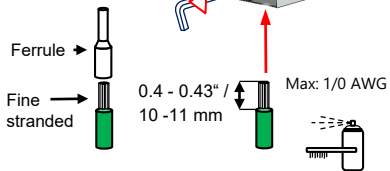

☰ Ground conduit nut if required by regulation

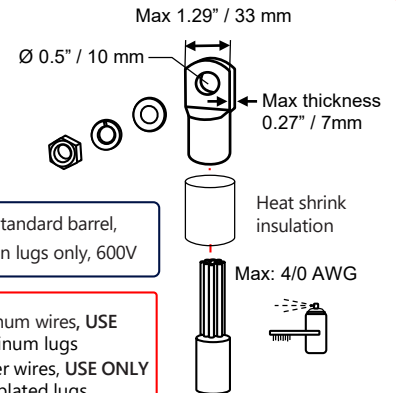

☰ One-hole, standard barrel, compression lugs only, 600V

- ⚠ • For aluminum wires, USE ONLY aluminum lugs
- For copper wires, USE ONLY copper tin-plated lugs

# LAN Communication

# 10

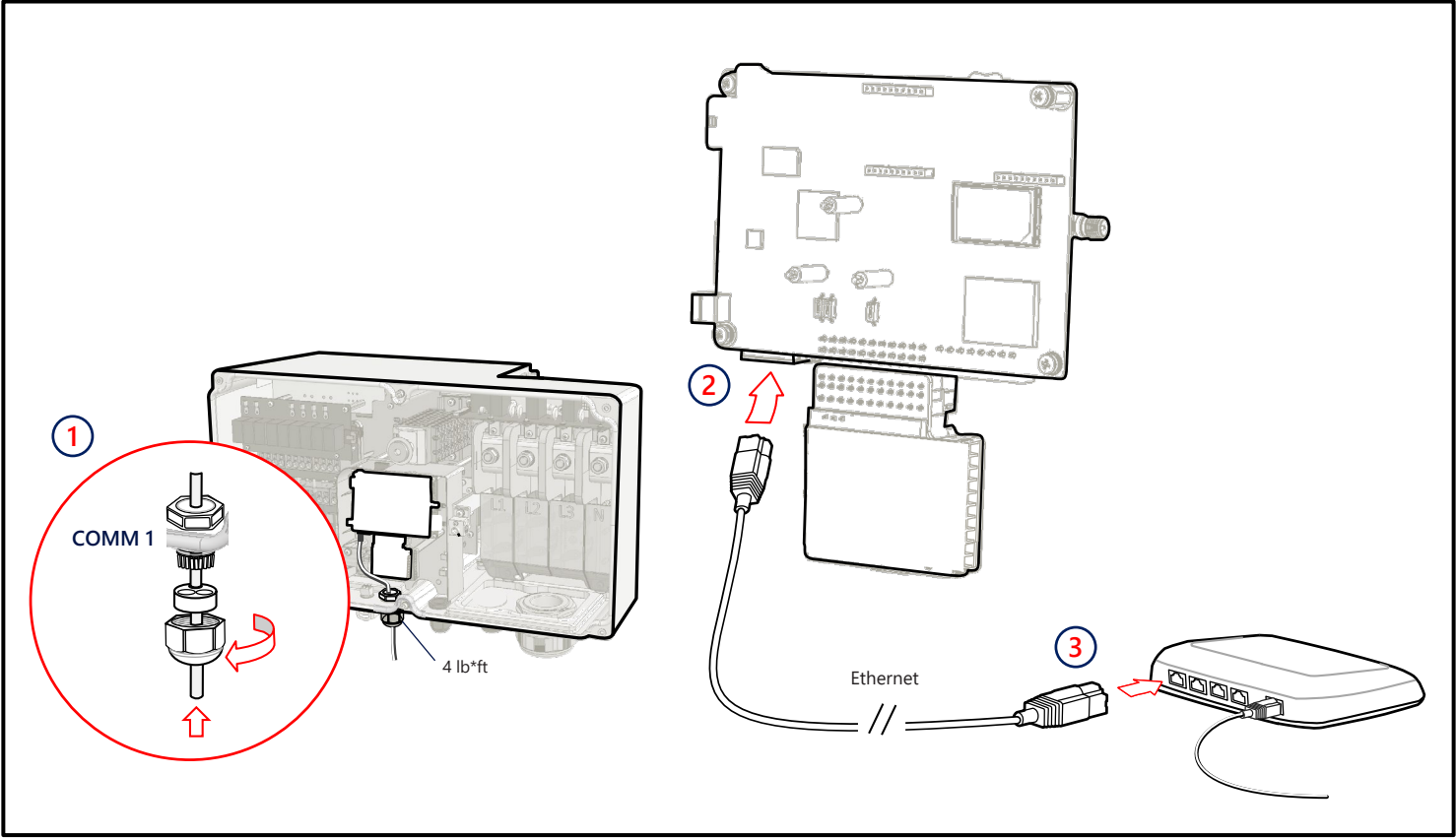



# 11 RS485 Connection of Multiple Inverters

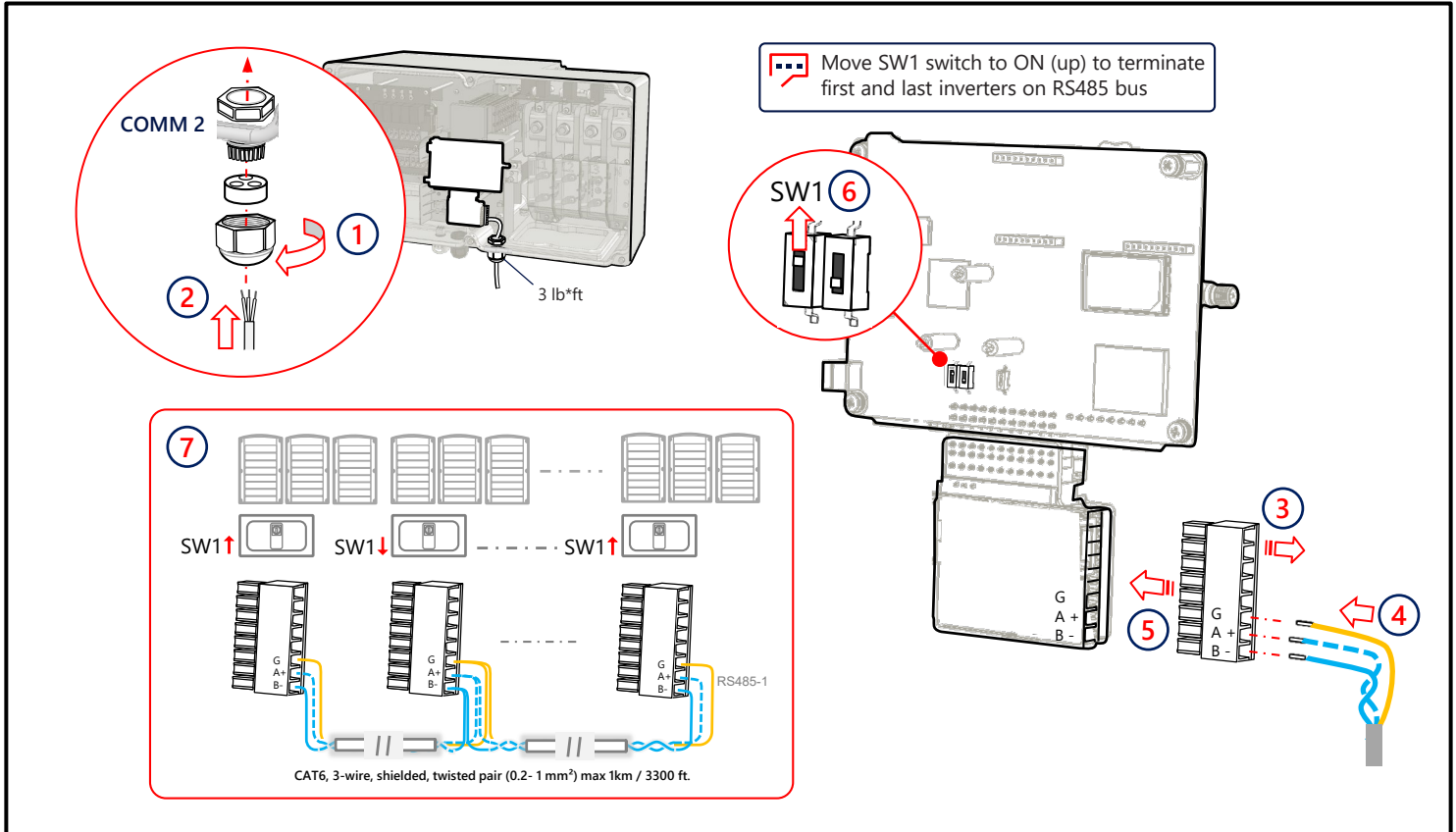



## 13

## Connecting Cellular Communication (Optional)

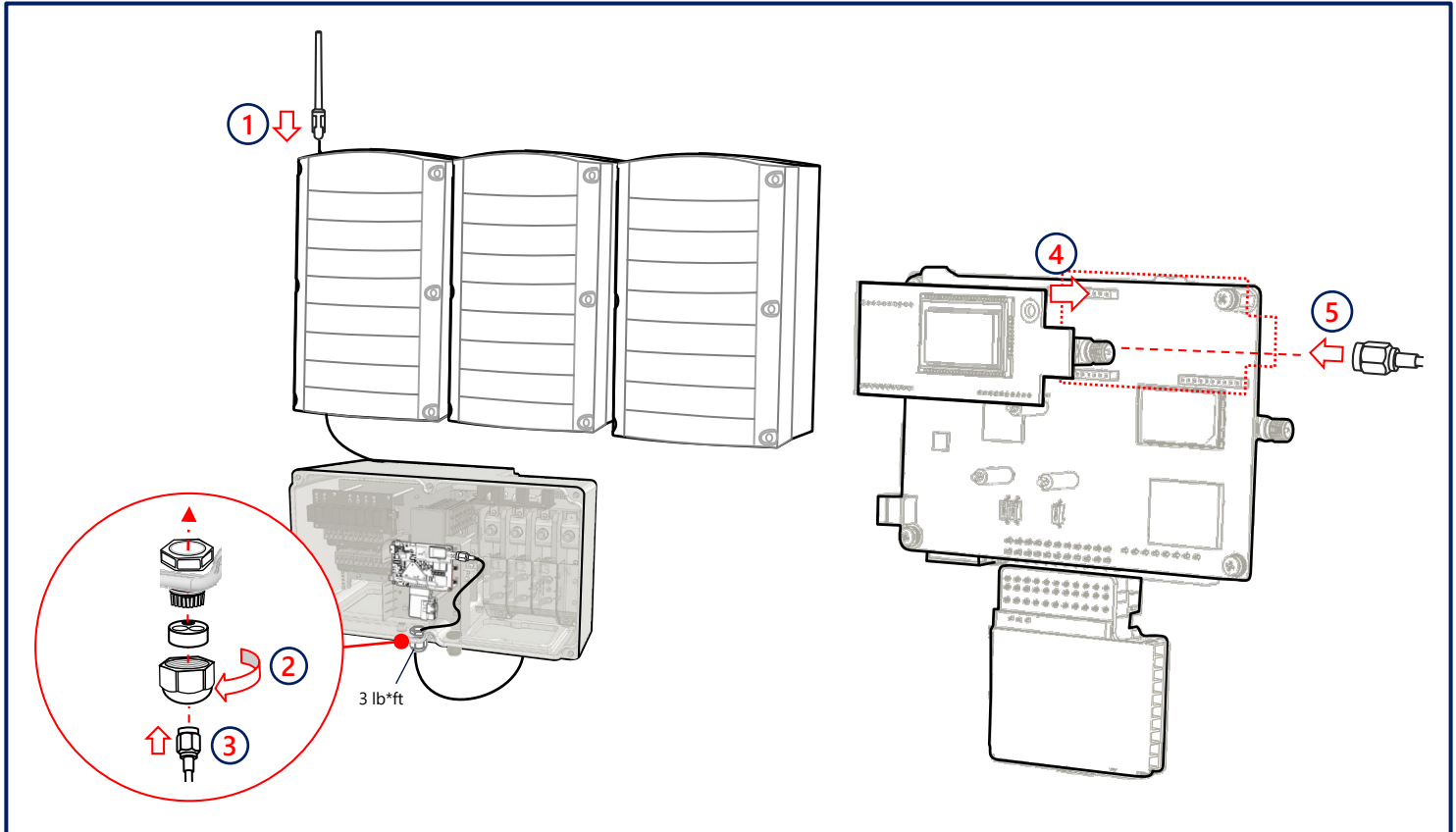

# Installing Covers

# 14

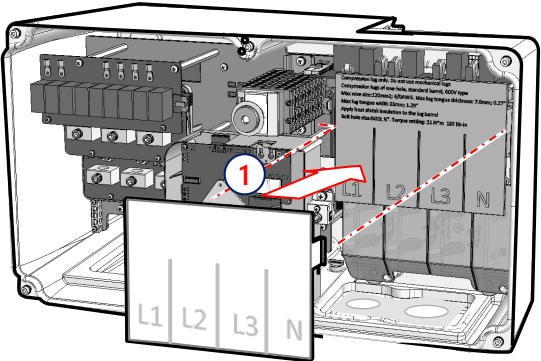
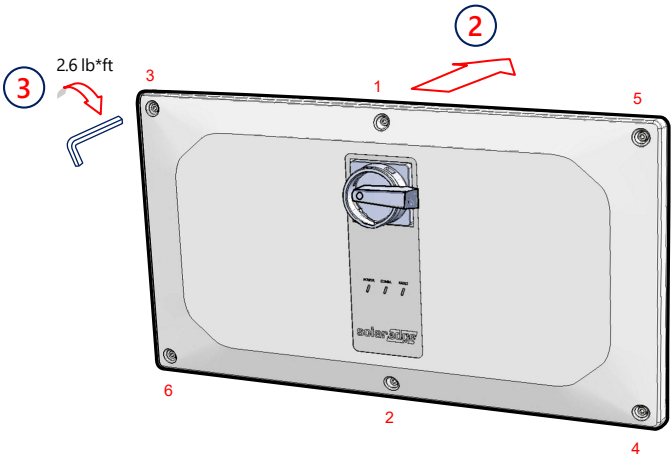

# 15 Pre-commissioning when AC Power is Not Connected (Option 1)

- 1 Download SolarEdge SetApp
- 2 Turn switch to ON
- 3 Connect power bank
- 4 Start and follow SetApp



GET IT ON  
Google Play

Download on the  
App Store

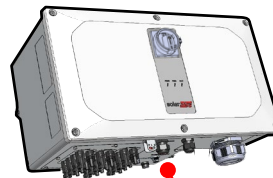

Power bank: 60W  
output port, USB-C  
Power Delivery (PD):  
20V 3A (not provided)

3.3 ft / 1 meter, USB-C / USB-C (not provided)

Cover connector  
when not used

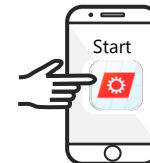

- 5 Disconnect and remove power bank
- 6 Turn switches to OFF
- 7 Wait until inverter turns-off (all LEDs turn-off)

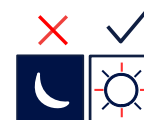

# Commissioning with DC and AC Power (Option 2)

# 16

1

Download  
SolarEdge SetApp



2

Turn switches to ON



3

Start & follow SetApp



# 17 Commissioning the Leader Inverter

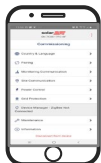

13:53 solar<sub>edge</sub> SN 7C17FC-8F













## Commissioning

- 1 Country & Language >
- 2 Pairing >
- 3 Site Communication >
- Monitoring Communication >
- Power Control >
- Grid Protection >
- Device Manager - ZigBee Not Connected
- Maintenance >
- Information >
- Central Setting >
- 4 Status >

RS485-1 → Protocol → SolarEdge → Solaredge Leader  
 RS485-1 → Follower Detect

Site		
Production 1.00 MW	Limit 1.00 MW	Inverters 10/10
Inverter SN 07318000C		
Power 100kW	Voltage 277 Vac	Frequency 60.9 Hz
P_OK: 141 of 141 Connected	Server Comm. S_OK (LAN)	
Status Production	Switch On	
Cos Phi 1.00	Limit No Limit	Country USA2

Inverter Units		
Left SN 07318000D	Center SN 07318000C	Right SN 07318000E
Power 33.3 kW	Power 33.3 kW	Power 33.3 kW
Voltage 850 Vdc	Voltage 850 Vdc	Voltage 850 Vdc
P_OK 47 of 47	P_OK 47 of 47	P_OK 47 of 47
Temperature 156 F	Temperature 156 F	Temperature 156 F
Fan OK	Fan OK	Fan OK
Isolation 100 kOhm	Isolation 100 kOhm	Isolation 100 kOhm

POWER	COMM	FAULT	
Green	Blue	Red	
			System is producing Power
			AC is connected but the system is not producing power
			Inverter is communicating with the monitoring platform
			System error



# Notes

---

---

---

---

---

---

---

---

---

---

---

---

---

---

---

---

---



### **Support Contact Information**

If you have technical problems concerning SolarEdge products, please contact us:

<https://www.solaredge.com/service/support>

Subject to change without notice.

Copyright © SolarEdge Inc.

All rights reserved. February 2022.



MAN-01-00786-1.6