

ITEM NO	DESCRIPTION	QTY IN KIT
1	QM, LID, J-BOX, BLK	1
2	HOUSING, J-BOX, BLK	1
3	GASKET, J-BOX	1
4	FLASHING, J-BOX, BLK	1
5	SELF-DRILLING WOOD SCREWS #12	2
6	THREAD FORMING SCREW FOR PLASTIC, #8 X .750"	2
7	#8-16 X 3/8" PHILLIPS DRIVE PAN HEAD	4
8	SCREW, PAN HEAD PHILLIPS, .250-20 UNC-2A	2
9	7" DIN RAIL	1
10	GROUND BAR KIT, 4 TERMINALS	1

PART NUMBER	DESCRIPTION
QM-JBX-RF02-B1	JAYBOX, ROOF-MOUNTED (COMP/ASPHALT SHINGLE)

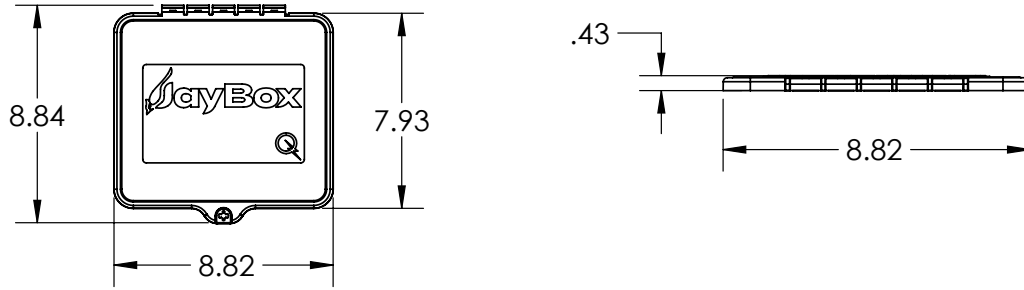

1) QM, LID, J-BOX, BLK



Property	Value
Material	NORYL
Finish	Black

2) HOUSING, J-BOX, BLK

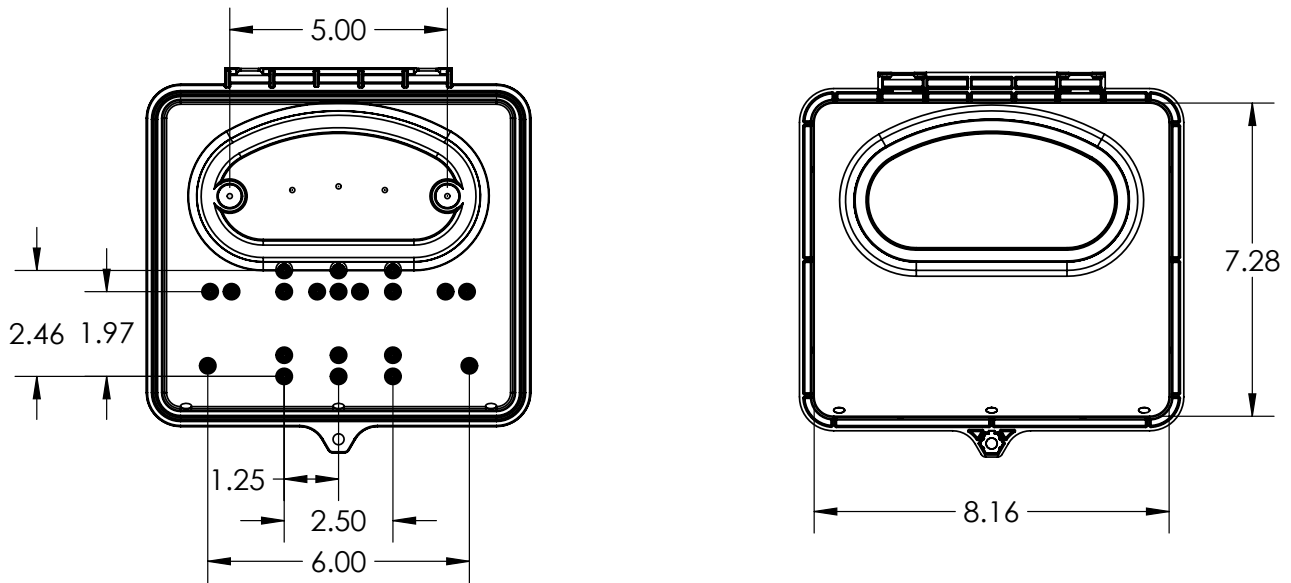

Property	Value
Material	NORYL
Finish	Black

3) GASKET, J-BOX



Property	Value
Material	EDPM
Finish	Black



4) FLASHING, J-BOX, BLK

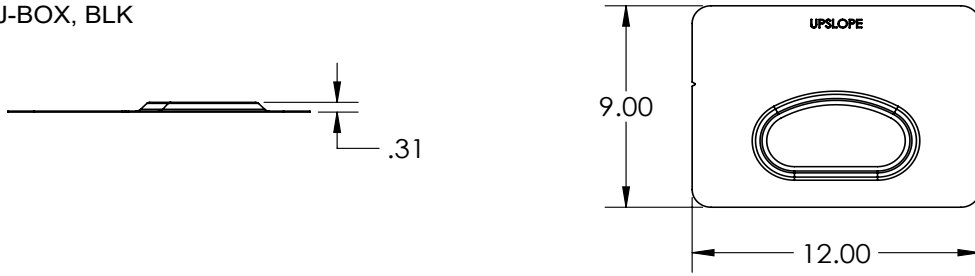

Property	Value
Material	3000 Series Aluminium
Finish	Black

5) SELF-DRILLING WOOD SCREWS, #12



Property	Value
Material	300 Series Stainless Steel
Finish	Clear

6) THREAD FORMING SCREW FOR PLASTIC, #8 X .750"

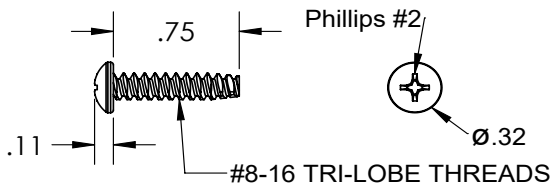

Property	Value
Material	300 Series Stainless Steel
Finish	Clear

7) #8-16 X 3/8" PHILLIPS DRIVE PAN HEAD

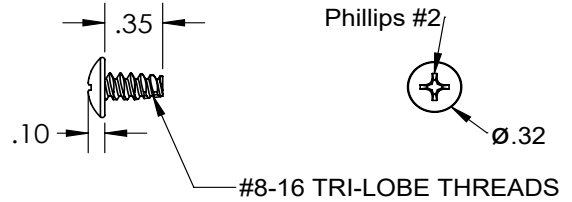

8) SCREW, PAN HEAD PHILLIPS, .250-20 UNC-2A

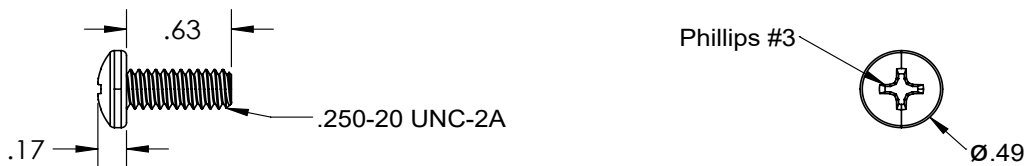

Property	Value
Material	300 Series Stainless Steel
Finish	Clear



## 9. 7" Din Rail

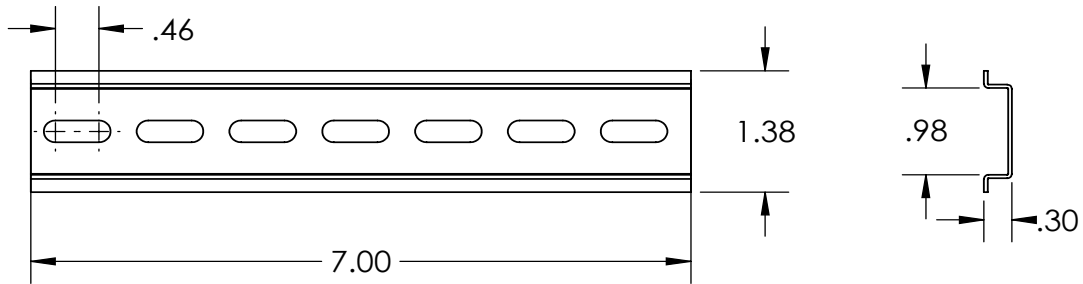

Property	Value
Material	300 Series Stainless Steel
Finish	Clear

## 10. Ground Bar Kit, 4 Terminals

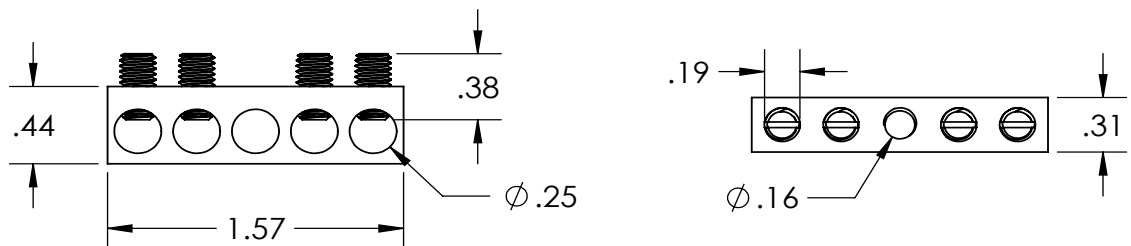

Property	Value
Material	6000 Series Aluminum
Finish	Mill

