

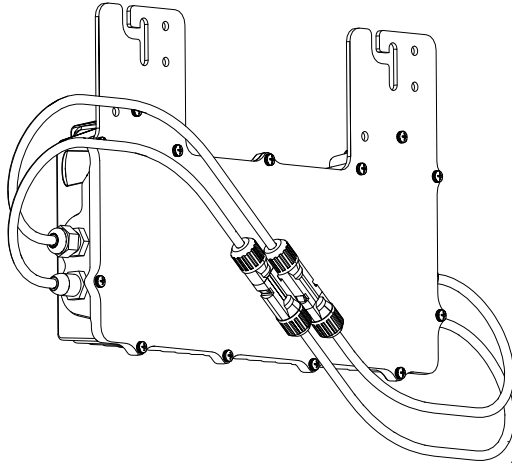

Installation Manual

Generac PV Link™ and SnapRS™



010023

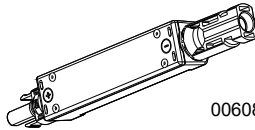

006087



WARNING

Loss of life. This product is not intended to be used in a critical life support application. Failure to adhere to this warning could result in death or serious injury. (000209b)

Register your Generac product at:

<https://pwrfleet.generac.com>

1-888-GENERAC
(888-436-3722)

Para español, visita: <http://www.generac.com/service-support/product-support-lookup>

Pour le français, visiter: <http://www.generac.com/service-support/product-support-lookup>

SAVE THIS MANUAL FOR FUTURE REFERENCE

Use this page to record important information about your Generac Product

Record PV Link™ and SnapRS™ information for your PWRcell system on this page.

When contacting a Generac Products Authorized Service Dealer (ASD) about parts and service, always supply complete model number and serial number information.

Operation and Maintenance: Proper maintenance and care of the energy storage system ensures a minimum number of problems and keeps operating expenses at a minimum. It is the operator's responsibility to perform all safety checks, to verify that all maintenance for safe operation is performed promptly, and to have the equipment checked periodically by an ASD. Normal maintenance, service and replacement of parts are the responsibility of the owner/operator and, as such, are not considered defects in materials or workmanship within the terms of the warranty. Individual operating habits and usage may contribute to the need for additional maintenance or service.

Table 1 - PV Link and SnapRS Important Information

PV Link Number	Location	Serial Number	RCP Number	Parallel Input?	Number of SnapRS	SnapRS Date of Manufacture
1						
2						
3						
4						
5						
6						

<p style="text-align: center;"> WARNING CANCER AND REPRODUCTIVE HARM www.P65Warnings.ca.gov (000393a)</p>
--

Table of Contents

Section 1 Introduction and Safety 1

Introduction	1
Safety Rules	1
General Hazards	2
PVRSE Warning	2
Electrical Hazards	3

Section 2 General Information 5

PV Link Specifications	5
SnapRS Specifications	5
Unit Dimensions	6
About PV Link	7
About Generac SnapRS	7
GFCI Information	7
AFCI Information	7
PVRSS Information	7
Component Locations	7

Section 3 Installation Design 9

Installation Design Worksheet	9
-------------------------------------	---

Section 4 PVRSS Compliance

Guidelines	11
-------------------------	-----------

Section 5 Mounting and

Connecting	13
-------------------------	-----------

Installation Guidelines	13
Attachment and Grounding	13
Connecting to Inverter	14
Connecting PV Modules	14

Section 6 Operating

Instructions	17
---------------------------	-----------

User Interface via Inverter	17
Commissioning the Rebus System	17
PVRSS Commissioning with SnapRS Devices	17
Disabling PV Link	19

AFD Self-Test	19
PVRSS Self-Test	19

Section 7 Maintenance21

Maintenance	21
Service	21

Section 8 Troubleshooting23

Section 1 Introduction and Safety

Introduction

Thank you for purchasing a Generac PWRcell product.

This manual provides instructions for installing PV Link and SnapRS devices. Consult the installation and operation manuals for other Generac PWRcell system components, as applicable.

The information in this manual is accurate based on products produced at the time of publication. The manufacturer reserves the right to make technical updates, corrections, and product revisions at any time without notice.



WARNING

Consult Manual. Read and understand manual completely before using product. Failure to completely understand manual and product could result in death or serious injury. (000100a)

If any section of this manual is not understood, contact the nearest Independent Authorized Service Dealer (IASD) or Generac Customer Service at 1-888-436-3722 (1-888-GENERAC), or visit www.generac.com for assistance. The owner is responsible for correct maintenance and safe use of the unit.

This manual must be used in conjunction with all other supporting product documentation supplied with the product.

SAVE THESE INSTRUCTIONS for future reference. This manual contains important instructions that must be followed during placement, operation, and maintenance of the unit and its components. Always supply this manual to any individual that will use this unit, and instruct them on how to correctly start, operate, and stop the unit in case of emergency.

Safety Rules

The manufacturer cannot anticipate every possible circumstance that might involve a hazard. The alerts in this manual, and on tags and decals affixed to the unit, are not all inclusive. If using a procedure, work method, or operating technique that the manufacturer does not specifically recommend, verify that it is safe for others and does not render the equipment unsafe.

Throughout this publication, and on tags and decals affixed to the unit, DANGER, WARNING, CAUTION, and NOTE blocks are used to alert personnel to special instructions about a particular operation that may be hazardous if performed incorrectly or carelessly. Observe them carefully. Alert definitions are as follows:

DANGER

Indicates a hazardous situation which, if not avoided, will result in death or serious injury.

(000001)

WARNING

Indicates a hazardous situation which, if not avoided, could result in death or serious injury.

(000002)

CAUTION

Indicates a hazardous situation which, if not avoided, could result in minor or moderate injury.

(000003)

NOTE: Notes contain additional information important to a procedure and will be found within the regular text of this manual.

These safety alerts cannot eliminate the hazards that they indicate. Common sense and strict compliance with the special instructions while performing the action or service are essential to preventing accidents.

How to Obtain Service

For assistance, contact the nearest Independent Authorized Service Dealer (IASD) or Generac Customer Service at 1-888-GENERAC (1-888-436-3722), or visit www.generac.com.

When contacting Generac Customer Service, always supply the complete model and serial number of the unit as given on its data decal located on the unit. Record the model and serial numbers in the spaces provided on the front cover of this manual.

General Hazards

▲ DANGER

Automatic start-up. Disconnect utility power and render unit inoperable before working on unit. Failure to do so will result in death or serious injury.

(000191)

▲ WARNING

Risk of injury. Do not operate or service this machine if not fully alert. Fatigue can impair the ability to service this equipment and could result in death or serious injury.

(000215)



▲ WARNING

Loss of life. This product is not intended to be used in a critical life support application. Failure to adhere to this warning could result in death or serious injury.

(000209b)

▲ WARNING

Hot Surfaces. Locate and install the PV Link so as to avoid inadvertent contact. When operating in hot weather the optimizer will become hot and could result in personal injury.

(000670)

▲ WARNING

Electric shock. Only a trained and licensed electrician should perform wiring and connections to unit. Failure to follow proper installation requirements could result in death, serious injury, and equipment or property damage.

(000155a)

▲ WARNING

Equipment damage. Only qualified service personnel may install, operate, and maintain this equipment. Failure to follow proper installation requirements could result in death, serious injury, and equipment or property damage.

(000182a)

▲ WARNING

Equipment damage. Never open the PV Link. The optimizer is factory-sealed and contains no field-serviceable parts. Opening the optimizer could result in equipment damage.

(000655)

▲ WARNING

Equipment damage. Never operate PV Link in ambient temperatures greater than 158° F (70° C). Operating PV Link in high temperature conditions will result in equipment damage.

(000669)

▲ CAUTION

Equipment damage. Connect only to REBus-compatible devices to the DC bus. Never connect to any other DC power source. Connecting to other DC power sources could result in equipment damage.

(000598a)

- Connecting Generac PWRcell to the electric utility grid must only be done after receiving prior approval from the utility company.

- Only competent, qualified personnel should install, operate, and service this equipment. Strictly comply to local, state, and national electrical and building codes. When using this equipment, comply with regulations established by the National Electrical Code (NEC), CSA Standard; the Occupational Safety and Health Administration (OSHA), or the local agency for workplace health and safety.

- Protection against lightning surges in accordance with local electric codes is the responsibility of the installer.

NOTE: Lightning damage is not covered by warranty.

- If working on this equipment while standing on metal or concrete, place insulative mats over a dry wood platform. Work on this equipment only while standing on such insulative mats.
- Never work on this equipment while physically or mentally fatigued.
- Any voltage measurements should be performed with a meter that meets UL3111 safety standards, and meets or exceeds overvoltage class CAT III.

PVRSE Warning

NOTE: SnapRS devices must be used in conjunction with Generac S2502 PV link to form a complete PVRSS per NEC 690.12

This Photovoltaic Rapid Shutdown Equipment (PVRSE) does not perform all of the functions of a complete Photovoltaic Rapid Shutdown System (PVRSS). This PVRSE must be installed with other equipment to form a complete PVRSS that meets the requirements of NEC (NFPA 70) section 690.12 for controlled conductors outside the array. Other equipment installed in or on this PV system may adversely affect the operation of the PVRSS. It is the responsibility of the installer to ensure the completed PV system meets the rapid shutdown functional requirements. This equipment must be installed according to the manufacturer's installation instructions.

Electrical Hazards



⚠ DANGER

Electrocution. Water contact with a power source, if not avoided, will result in death or serious injury.

(000104)



⚠ DANGER

Electrocution. In the event of electrical accident, immediately shut power OFF. Use non-conductive implements to free victim from live conductor. Apply first aid and get medical help. Failure to do so will result in death or serious injury.

(000145)



⚠ DANGER

Electrocution. Turn battery disconnect OFF and de-energize REBus before touching terminals. Failure to do so will result in death, serious injury, equipment and property damage.

(000599)



⚠ DANGER

Electrocution. Verify electrical system is properly grounded before applying power. Failure to do so will result in death or serious injury.

(000152)



⚠ DANGER

Electrocution. Do not wear jewelry while working on this equipment. Doing so will result in death or serious injury.

(000188)

⚠ WARNING

Electric Shock. Avoid contact with DC conductors. DC conductors of this photovoltaic system are ungrounded and may be energized regardless of sun exposure. Contact with conductors could result in death or serious injury.

(000666)



⚠ WARNING

Electrocution. Potentially lethal voltages are generated by this equipment. Render the equipment safe before attempting repairs or maintenance. Failure to do so could result in death or serious injury.

(000187)

This page is intentionally left blank

Section 2 General Information

PV Link Specifications

Description	Units	S2502
Rated power	W	2500 (continuous)
Peak efficiency	%	99
MPPT input voltage	VDC	60–360
Rated power input voltage	VDC	200–360
Maximum input voltage	VDC	420 (absolute maximum)
Maximum input current (operating)	A °F (°C)	13 @ 122 (50)
Maximum input current (short circuit)	A	18
Maximum output current (fault)	A	10
Maximum output voltage	VDC	420 (open circuit)
Nominal output	-	REbus DC nanogrid (380 VDC + data)
Maximum output current (continuous)	A	8
Standby power	W	<1
Topology	-	Boost converter
Protections	-	Ground-fault protection, arc-fault protection (type 1), PVRSE
Operating temperature range	°F (°C)	-40 (-40) to 158 (70)
Enclosure	-	NEMA Type 3R
Weight	lb (kg)	7.3 (3.3)
Certifications	-	UL 1741

Specifications are subject to change without notice. Refer to the product specification sheet for complete list.

SnapRS Specifications

Description	Units	RS801
PV module maximum VOC	V	75
Maximum number of PV modules per string	-	9*
Efficiency	%	99.8**
Maximum input current	A	13
Shutdown time	Sec	< 10
Enclosure rating	-	NEMA Type 6P
Operating temperature range	°F (°C)	-40 (-40) to 158 (70)
Certifications	-	UL 1741
Weight	oz (g)	3.5 (100)

* 1 SnapRS per PV module.

** Used with a 50 V PV Panel.

Specifications are subject to change without notice. Refer to the product specification sheet for complete list.

Important Product Information

PV Link Serial Number Location

See [Figure 2-1](#). Serial number tag (A) includes a removable layer that can be peeled off leaving the underlying label in place. Adhere the removable layer to the inside cover of this manual and record the information from this tag in [Table 1: PV Link and SnapRS Important Information](#).

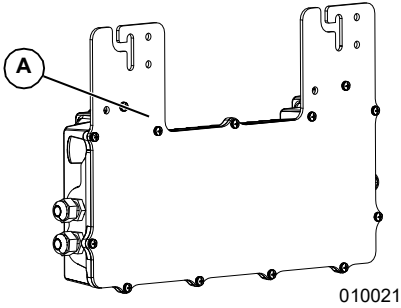

Figure 2-1. Serial Number Location

SnapRS Date of Manufacture

Refer to [Figure 2-2](#) to locate the unit date of manufacture. Record this information in [Table 1: PV Link and SnapRS Important Information](#) on the inside front cover of this manual.

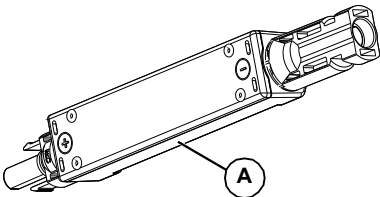

Figure 2-2. Date of Manufacture

Unit Dimensions

PV Link Dimensions

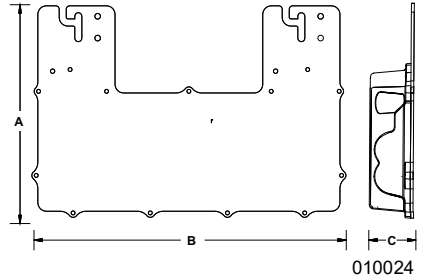

Figure 2-3. Unit Dimensions

A	9-9/16 in (243 mm)
B*	15-1/2 in (390 mm)
C	2-1/16 in (53 mm)

*18-1/8 in (460 mm) with PV wire bend radius

SnapRS Dimensions

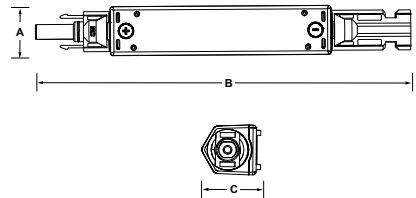

Figure 2-4. Unit Dimensions

A	7/8 in (22 mm)
B	7 in (152 mm)
C	1 in (25 mm)

About PV Link

The PV Link is a nonisolated, interleaved DC-DC converter that boosts PV input to a higher voltage and outputs it to Rebus™, Generac's regulated 380 VDC bus. The PV Link provides droop-mode power management, enabling multiple optimizers to connect in parallel on a common bus, and its DC output carries a bidirectional power line communication (PLC) protocol for communicating with inverters and other devices on REbus.

The PV Link is sealed in a type 3R enclosure at the factory and is designed for attachment to standard PV racking. Safety features include ground fault detection, arc fault detection, and rapid shutdown capability.

About Generac SnapRS

SnapRS is an inline PV rapid-shut down device that satisfies 2017 and 2020 NEC 690.12 PV rapid shutdown system (PVRSS) requirements. When used with PV Link, SnapRS devices limit all controlled conductors within an array's 1 ft (305 mm) boundary to 80 VDC or less within 30 seconds of rapid shutdown initiation.

GFCI Information

The PV Link's internal ground-fault circuit interrupter (GFCI) is designed to trip at 240 mA (\pm 40 mA) of PV DC voltage ground current. Ground faults are displayed on the PWR-cell inverter control panel. The PV Link meets the ground-fault protection requirements in NEC Article 690.41(B).

AFCI Information

The PV Link is a Photovoltaic DC Arc-Fault Circuit Protection Type 1 device that incorporates an internal arc fault circuit interrupter (AFCI) and meets the Arc-Fault circuit protection requirement in NEC Article 690.11.

PVRSS Information

PV rapid shutdown system (PVRSS) requirements have evolved over time and are defined by the National Electrical Code (NEC) in conjunction with UL 1741. Determine what level of rapid PV shutdown is required for your jurisdiction.

- The 2011 NEC and older editions do not require PVRSS capability.
- The 2014 NEC requires rapid shutdown only on the conductors leaving the PV array.
- The 2017 and 2020 NEC require rapid shutdown at the PV module level and on the conductors leaving array.

PV Link is a PV rapid shutdown system equipment (PVRSE) component within a PVRSS. It only provides rapid shutdown for the conduc-

tors leaving the array. SnapRS devices are required for PV module level rapid shutdown. See [PVRSS Compliance Guidelines](#) for more information.

Component Locations

PV Link Component Locations

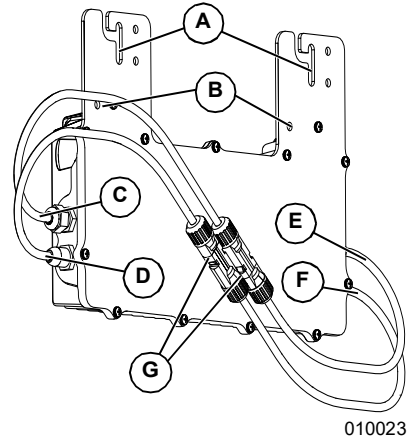

Figure 2-5. Component Locations

- A Attachment Flange Slots
- B Grounding Terminals (sized for 1/4 in hardware)
- C REBus DC Nanogrid Output Negative (-) Lead
- D REBus DC Nanogrid Output Positive (+) Lead
- E PV Substring Input Negative (-) Lead
- F PV Substring Input Positive (+) Lead
- G MC4 Connectors

SnapRS Component Locations

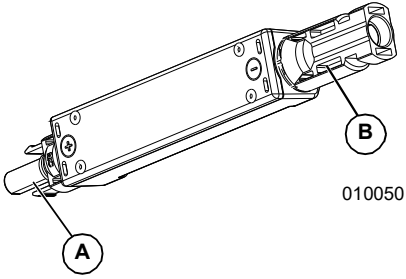

Figure 2-6. Component Locations

- A** Positive PV Connector
- B** Negative PV Connector

Section 3 Installation Design

Installation Design Worksheet

Use this worksheet to determine the maximum number of PV modules of a given type that can be connected to a PV Link.

NOTE: Fewer PV modules can be used as long as the minimum MPPT input voltage is met.

1. Calculate an adjusted open circuit voltage (VOC) for the module being installed using the applicable NEC cold factor from [Table 1: NEC Cold Factor](#).

NOTE: The temperature correction factor listed on the module nameplate can be used if available.

Panel VOC	X	NEC Cold Factor	=	Adjusted VOC

2. Divide the PV Link Max VOC by the Adjusted VOC from step 1 and round down to determine the number of panels that can be connected in series to the PV Link without exceeding the open-circuit voltage limit.

PV Link Max VOC	÷	Adjusted VOC	=	VOC Limit Result
420 V				

3. Divide the PV Link VMP (Voltage at Maximum Power) by the panel VMP and round down to determine the number of panels that can be connected in series to the PV Link without exceeding maximum power voltage.

PV Link Max VMP	÷	Panel VMP	=	VMP Limit
360 V				

4. Compare the results from step 2 and step 3 and choose the smaller number. Round down to the nearest integer and record it below. This is the maximum number of modules of this type that can be connected to the PV Link given the specified NEC cold factor.

Maximum Panels per Substring

Table 1 - NEC Cold Factor

Minimum Temperature (°F)	NEC Cold Factor	Minimum Temperature (°C)
49 to 41	1.08	9 to 5
40 to 32	1.10	4 to 0
31 to 23	1.12	-1 to -5
22 to 14	1.14	-6 to -10
13 to 5	1.16	-11 to -15
4 to -4	1.18	-16 to -20
-5 to -13	1.20	-21 to -25
-14 to -22	1.21	-26 to -30
-23 to -31	1.23	-31 to -35
-32 and below	1.25	-36 and below

This page is intentionally left blank

Section 4 PVRSS Compliance Guidelines

2011 NEC and Older Editions

2011 NEC and older editions do not require PVRSS compliance.

NOTE: The PV Link will still provide 2014 NEC compliant PV Rapid Shutdown.

2014 NEC

The 2014 NEC 690.12 introduced a new requirement for PV systems that is commonly referred to as PV rapid shutdown.

To meet 2014 NEC compliance:

1. Install the PWRcell inverter as specified in the Generac PWRcell Inverter Installation Manual.
2. Install the PV Link as specified in this manual.
3. The DC disconnect under the PWRcell inverter cover labeled PV by the installer can be used as the PVRSS initiation device. See Shutdown in the Generac PWRcell Inverter Installation Manual for more information.

Rapid shutdown response time is less than 30 seconds.

2017 and 2020 NEC

The 2017 and 2020 NEC have PVRSS requirements mandating the need to reduce voltages of controlled conductors to less than 80 VDC within the array, as well as some specification for the location of the PVRSS initiator and its labeling.

To meet 2017 and 2020 compliance:

1. The 2017 and 2020 NEC requires the PVRSS initiator be located at a readily accessible location outside the building.
 - The DC disconnect under the PWRcell inverter cover labeled PV by the installer can be used as the PVRSS initiation device.

NOTE: Provide signage indicating the PVRSS initiation device is the REbus PV DC disconnect located under the front cover of the inverter.

- An externally mounted PVRSS initiation device is required to be installed at a readily accessible location when the PWRcell inverter is installed within a one- or two-family dwelling unit.

NOTE: Provide signage indicating where PVRSS initiation devices are located. Note that if the inverter is installed in the appropriate outdoor location it may satisfy this requirement.

2. Provide signage complying with section 690.56(C) of the NEC (NFPA 70), stating all conductors are controlled.

NOTE: Install one SnapRS to the negative whip (-) of each PV module connected to the PV Link.

3. Install the PV Link. See [Installation Guidelines](#) for more information.

Upon initiation of rapid shutdown, both inputs and outputs of the PV Link are controlled to be less than 80 VDC. Rapid shutdown response time is less than 30 seconds, in accordance with section 690.12 of the NEC (NFPA 70).

This page is intentionally left blank

Section 5 Mounting and Connecting

Installation Guidelines

⚠ WARNING

Hot Surfaces. Locate and install the PV Link so as to avoid inadvertent contact. When operating in hot weather the optimizer will become hot and could result in personal injury.

(000670)

- Install PV Links close to the edge of the array for best cooling and easier service access.
- Calculate maximum substring length using the *Installation Design Worksheet* worksheet in Section 3 of this manual.
- The modules within each substring must be the same type, and all should be mounted at the same pitch and orientation.
- When installing a system with multiple PV Links, it is not necessary to match the number of modules, roof pitch, or orientation across all substrings in an array.
- Ensure at least a 1 in (25.4 mm) clearance between the heatsink fins and adjacent surfaces to allow sufficient air flow for cooling.
- The PV Link can be installed in any orientation. Cooling is most effective if fins are oriented vertically and facing away from the PV panel.
- Mount the optimizer at least 3 ft (0.9 m) from the ground.
- Review the PV module instructions to determine if any restrictions for mounting devices under the module exist as part of the PV module listing.

Attachment and Grounding

⚠ CAUTION

Equipment damage. Never leave the PV Link MC4 connectors open and exposed to the atmosphere overnight or during rain. Doing so could cause equipment failure.

(000657)

NOTE: Proper grounding is necessary for REbus communication.

Installing to Metallic or Grounded Structures

See [Figure 5-1](#). If mounting PV Link underneath an array to metallic PV racking, install the PV Link with label (A) facing up. Attachment flange slots (B) accept fasteners up to M8 or 5/16" in diameter.

Installing to Nonmetallic or Ungrounded Structures

- Use two fasteners appropriate for the structure.
- See [Figure 5-1](#). Fasten to grounding terminal (C) the equipment grounding conductor using a field supplied lug.
- Use listed bonding hardware only.
- Size equipment grounding conductor per NEC requirements and torque per manufacturer specifications.

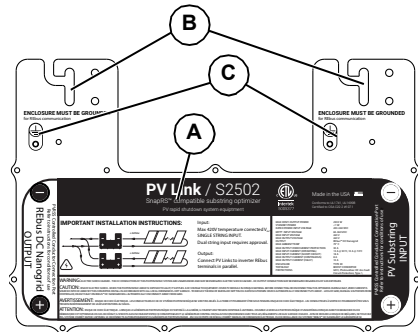

Figure 5-1. Grounding Terminal Location

Installing to a Grounded Rail

- See [Figure 5-1](#). Use two rail-compatible fasteners (D) to secure the PV Link to the grounded rail.
- Use a grounding washer (E) between the rail and attachment flange to penetrate the rail's anodized coating.
- Torque fasteners according to the clip manufacturer's instructions.

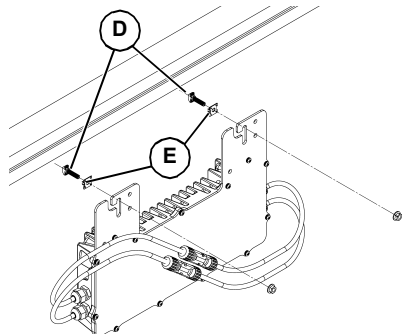

Figure 5-2. Attaching to a Grounded Metal Rail

Connecting to Inverter

⚠ CAUTION

Equipment damage. Connect the PV Link output to a REBus-compatible device (\pm 190 VDC nominal regulated DC bus) only. Connecting to conventional PV inverters or any other device could cause equipment damage.

(000659)

See [Figure 5-3](#). Connect each PV Link output to the REBus DC nanogrid and inverter.

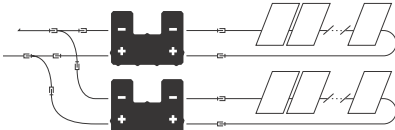

010027

Figure 5-3. Connecting PV Link Optimizer

When connecting optimizers to the inverter:

- Do not reverse the input and output or cross-wire polarity. To avoid confusion, complete the wiring of the PV Link output before installing PV modules.
- Do not connect PV Link optimizers in series.
- Connect multiple PV Link outputs in parallel. To connect PV Links in parallel:
 - Connect all negative (RE-) PV Link outputs on a home run together.
 - Connect all positive RE (+) outputs on a home run together.
- Current adds when connecting optimizers in parallel. The maximum output current of each PV Link is 8 A. When wiring PV Link outputs to the inverter, observe temperature ratings and current-carrying capacity of the wire used, including appropriate NEC derating factors.

NOTE: Multiple home-runs will be necessary in larger systems.

- Connect field wiring to the PV Link with Staubli MC4 PV connectors only.
- Mark positive REBus field wiring leads with red insulation or flagging.
- Mark negative REBus field wiring leads with blue insulation or flagging.
- Connect multiple optimizers in parallel, using MC4 branch connectors or a combiner box.

Connecting PV Modules

⚠ CAUTION

Equipment damage. Never leave the PV Link MC4 connectors open and exposed to the atmosphere overnight or during rain. Doing so could cause equipment failure.

(000657)

⚠ CAUTION

Equipment damage. Never connect PV Link to any other power source. The optimizer is designed to work with series connected PV modules only. Connecting the optimizer to any other power source could cause equipment damage.

(000661)

NOTE: Warranty does not cover water ingress through wiring from external connections due to poor wiring practices.

2014 NEC and Earlier Editions

For NEC 2014 compliant systems, connect the substring PV modules in series.

To install PV modules in series to PV Link:

1. Connect the negative lead of the first module in the string to the PV Link at the location marked PV Substring Input (-). See [Component Locations](#) for PV Input location.
2. Connect the first module's positive lead to the second module's negative lead.
3. Continue connecting the substring module leads in series until the last module is reached.
4. Connect the positive lead of the last module in the substring to the PV Link at the location marked PV Substring Input (+). See [Component Locations](#) for PV input location.
5. Make a string map using the serial number stickers and record in [Table 1: PV Link and SnapRS Important Information](#) the following information:
 - Each PV Link serial number
 - Each PV Link RCP number
 - Number of parallel strings

2017 and 2020 NEC Compliant Systems

For NEC 2017 and 2020 NEC compliant systems, connect the string PV modules in a series using one SnapRS device per module.

Installing SnapRS Devices

NOTE: Pre-install SnapRS devices to PV modules to ensure a 1:1 ratio.

When installing SnapRS devices consider the following:

- Each PV Link can control a connected string of PV modules with a string voltage between 60–420 VDC. For string sizing guidance, see [Installation Design Worksheet](#).
- The positive (+) end of one (1) SnapRS device must be installed to the negative (-) lead of each PV module in the array.
- PV modules require Staubli (Multi-Contact) MC4 connectors. Brands other than Staubli MC4 connectors are not recommended.

NOTE: MC connectors are not watertight unless mated. Never leave this system partially assembled.

- See [Figure 5-4](#). PV modules are installed in series with SnapRS devices connected inline between each module.
- See [Figure 5-5](#). High-voltage modules can be configured in parallel strings.

NOTE: Install SnapRS devices prior to securing PV modules to the racking.

To install SnapRS devices:

1. See [Figure 5-4](#). For each PV module in the PV string, connect the positive (+) end of one SnapRS device (C) to the negative (-) whip of the PV Module (D).
2. Connect the negative (-) end of each SnapRS device to the positive (+) whip of the next PV module in the series.
3. Connect the PV string positive lead to PV Link (B) at the location marked PV Substring Input + (F). See [Component Locations](#) for more information.
4. Connect the PV string negative lead with its connected SnapRS device to PV Link (B) at the location marked PV Substring Input - (E). See [Component Locations](#) for more information.
5. Secure the SnapRS devices to the racking or module frame using zip ties or a similar fastener.

NOTE: When connecting the PV string to the PV Link, the PV Link MC4 connector labeling will indicate the same polarity as the PV string connector (ex. PV Link positive (+) will connect to the (+) whip of the first PV module in the string). This will also be true with SnapRS installed on the negative (-) whip. This is intentional and differs from the connection method for combining PV modules together with SnapRS..

6. Make a string map using the PV Link peel-and-stick serial number stickers and record in [Table 1: PV Link and SnapRS Important Information](#) the following information:
 - Each PV Link serial number
 - Each PV Link RCP number
 - Number of parallel strings
 - SnapRS devices per string
 - SnapRS date of manufacture.

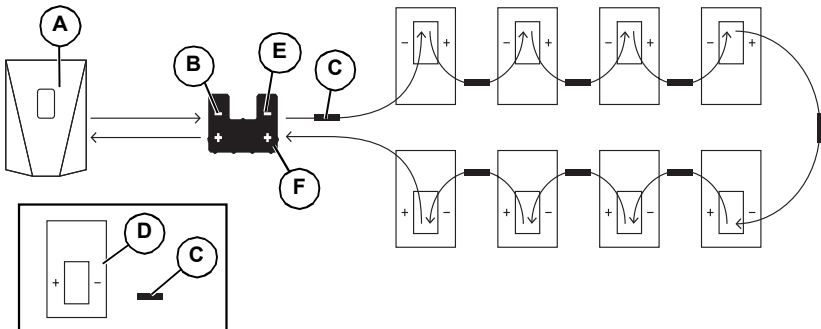

Figure 5-4. Single-String PV Array with SnapRS Device

A	PWRcell Inverter	D	PV module
B	PV Link	E	PV Substring Input -
C	SnapRS Device	F	PV Substring Input +

NOTE: See [Figure 5-5](#). When dual strings are connected in parallel, each string must use the same number of the same type of PV modules, and there must be one SnapRS device for each module in the array.

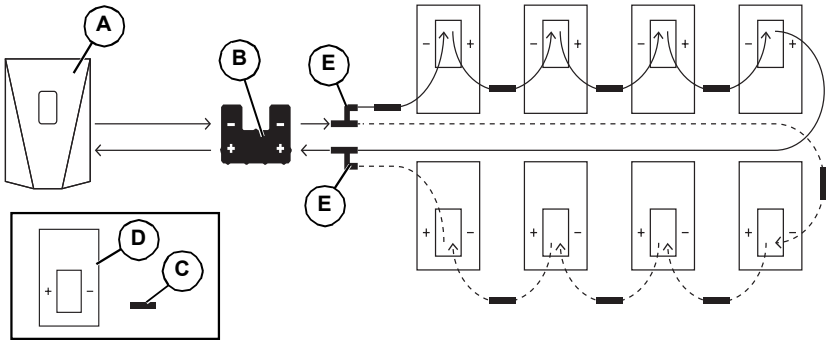

Figure 5-5. Parallel-Input PV Array with SnapRS Devices

- | | | | |
|----------|------------------|----------|----------------------|
| A | PWRcell inverter | D | PV module |
| B | PV Link | E | MC4 branch connector |
| C | SnapRS device | | |

Section 6 Operating Instructions

User Interface via Inverter

PV Link Information and control features are available on the PWRcell inverter control panel when REbus is energized. See the Generac PWRcell Inverter Owner's Manual for more information.

See [Figure 6-1](#). To access the device page for each PV Link, use left or right arrow buttons (A) on the inverter control panel to scroll through the pages. When on a PV Link device page, press center button (B) to enable or disable the device or to modify settings. The disabled/enabled state does not affect communication with the inverter.

NOTE: The PV Link only produces power after the REbus DC nanogrid has been established and the device has been enabled.

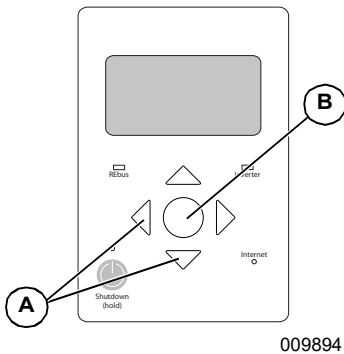

Figure 6-1. Inverter Control Panel

Commissioning the Rebus System

The PV Link ships from the factory in a disabled state. Each unit must be enabled from the PWRcell inverter control panel. Once enabled, the PV Link automatically detects the REbus nanogrid and begins to export power when the bus is within normal operating specifications.

See the Generac PWRcell Inverter Installation Manual for instructions on commissioning the REbus system.

PVRSS Commissioning with SnapRS Devices

To enable PV Link to work as a PVRSS with SnapRS devices:

1. Press the right arrow button on the control panel repeatedly until the device page appears.

NOTE: The device page display should read Disabled. If it does not read Disabled, press the center button and disable the device.

2. See [Figure 6-2](#). Press the center button and select Mod. Settings to access device settings and options.
3. Record the RCPn number in [Table PV Link and SnapRS Important Information](#), found on the front cover of this manual.

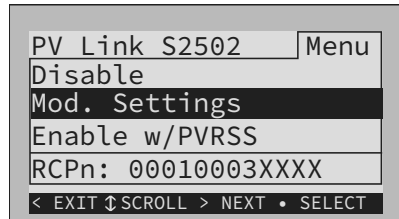

Figure 6-2. PVRSS Commissioning (1 of 4)

4. See [Figure 6-3](#). If installing a dual string array, select Mod. Settings and update the String Count value to 2.

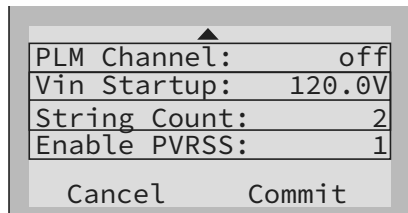

Figure 6-3. PVRSS Commissioning (2 of 4)

5. See [Figure 6-4](#). Press the center button and select Enable w/PVRSS to enter the Testing PVRSS state.

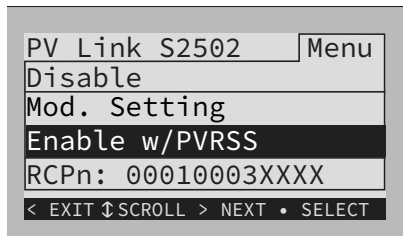

Figure 6-4. PVRSS Commissioning (3 of 4)

6. See [Figure 6-5](#). The LCD will display Testing PRVSS during the testing process. Upon completion, the LCD will read Low Sun or Making Power, depending upon available PV voltage.

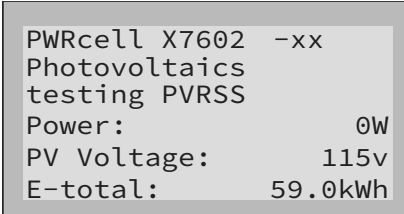

Figure 6-5. PVRSS Commissioning (4 of 4)

7. Complete steps 1-6 for each PV link in the system.

NOTE: To verify a PV Link is working properly, navigate to the Mod.Settings page and confirm the SnapRSInstalld value matches the number of SnapRS devices connected to that PV Link.

TABLE 2. PVRSS Commissioning Troubleshooting

Message	Cause	Solution
PVRSS fail: high input	The voltage detected with SnapRS devices disabled is higher than expected.	<ul style="list-style-type: none"> Verify the SnapRS devices are installed correctly. Run the PVRSS self-test. SnapRS devices have not been installed or have failed.
PVRSS not configured	PVRSS is enabled on the optimizer, but the SnapRSInstalld device setting indicates no SnapRS devices are installed.	Follow the instructions in the PVRSS Commissioning with SnapRS Devices section. See PVRSS Commissioning with SnapRS Devices .
PVRSS count mismatch	The number of SnapRS devices listed in the SnapRSInstalld device setting does not match the detected number of SnapRS devices.	Check the Mod. Settings and update the SnapRSInstalld value to reflect the number of installed SnapRS devices.
PVRSS fail: low input	The panel output voltage is too low to accurately count the SnapRS devices.	If the failure occurs with normal exposure to sunlight, contact the nearest Independent Authorized Service Dealer (IASD) or Generac Customer Service at 1-888-436-3722 (1-888-GENERAC), or visit www.generac.com for assistance.

If the failure persists, contact the nearest Independent Authorized Service Dealer (IASD) or Generac Customer Service at 1-888-436-3722 (1-888-GENERAC), or visit www.generac.com for assistance.

Disabling PV Link

NOTE: Disabling a PV Link does NOT de-energize the PV array if SnapRS devices are not installed. If SnapRS devices are installed, in-array voltages are limited to less than 80 VDC.

NOTE: Disabling PV Link does not de-energize the DC bus if other devices are providing power to the DC bus.

NOTE: The disabled/enabled state of each PV Link persists through AC power outages and DC bus power cycling.

To disable a PV Link:

1. On the PWRcell inverter control panel, use the left or right arrows to scroll to the page for the desired PV Link.
2. Press the center button to enter device settings.
3. Use the up and down arrows to highlight Disable and press the center button to select.
4. Arrow right and press the center button to Confirm.
5. Repeat steps 1–4 to disable any additional optimizers in the system.

NOTE: Repeat the process to re-enable each optimizer.

AFD Self-Test

NOTE: Arc fault detection is always enabled.

Performing an arc fault detection (AFD) self-test confirms arc fault functionality is working properly. When an arc fault is detected, the status message reads Arc Fault.

To conduct an AFD test:

1. On the PWRcell inverter control panel, use the left or right arrows to scroll to the page for the desired PV Link.
2. Press the center button to enter device settings.
3. Use the up and down arrows to highlight Test AFD and press the center button to enter the test state.
4. Arrow right and press the center button to Confirm

Upon test completion, the control panel will display a result of Test Success or Test Failure. After a few seconds, the AFD test will automatically clear.

PVRSS Self-Test

After commissioning, you can verify proper function and configuration of the PVRSS system at any time by manually running the PV Link PVRSS self-test.

To run the PVRSS self-test:

1. On the PWRcell inverter control panel press the right arrow button repeatedly until the first PV Link device page appears.

NOTE: The device page display should read Disabled. If it does read not Disabled, press the center button and Disable the PV Link.

2. Press the center button and select Test PVRSS. to enter the Testing PVRSS state.

The display indicates Testing PVRSS during the test process, which can take up to three minutes. Upon successful completion, the display will read: Test Success. The PV Link (s) will automatically re-enable.

This page is intentionally left blank

Section 7 Maintenance

WARNING

Equipment damage. Never open the PV Link. The optimizer is factory-sealed and contains no field-serviceable parts. Opening the optimizer could result in equipment damage.

(000655)

Maintenance

See [Figure 7-1](#). To ensure maximum performance, keep heatsink fins (A) free of leaves and other debris.

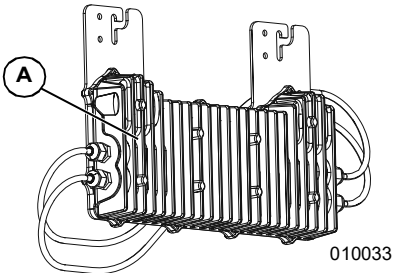

Figure 7-1. Heatsink Fins

The PV Link does not require regular maintenance and contains no user-serviceable parts.

Service

If the PV Link is not operating as expected, or if a PV Link error message appears on the Generac PWRcell Inverter control panel LCD display, contact the nearest Independent Authorized Service Dealer (IASD) or Generac Customer Service at 1-888-GENERAC (1-888-436-3722), or visit www.generac.com for assistance.

This page is intentionally left blank

Section 8 Troubleshooting

CAUTION

Equipment damage. Connect the PV Link output to a REbus-compatible device (± 190 VDC nominal regulated DC bus) only. Connecting to conventional PV inverters or any other device could cause equipment damage.

(000659)

There are no functional tests that can be performed on SnapRS devices in the field. However, some simple digital multimeter (DMM) checks can confirm the general health of a SnapRS device.

DMM Red to SnapRS +, DMM Black to SnapRS –

Resistance reads ~ 300 k Ω to 350 k Ω

Diode check reads ~ 0.50 V to 0.55 V

DMM Red to SnapRS –, DMM Black to SnapRS +

Resistance reads ~ 12 M Ω

This page is intentionally left blank

Part No. DMAN00013 Rev. B 05/07/2020

©2020 Generac Power Systems, Inc.

All rights reserved

Specifications are subject to change without notice.

No reproduction allowed in any form without prior
written consent from Generac Power Systems, Inc.

GENERAC[®]

Generac Power Systems, Inc.
S45 W29290 Hwy. 59
Waukesha, WI 53189

1-888-GENERAC (1-888-436-3722)

www.generac.com