

# QBase® Shake & Slate Mount | QMNS

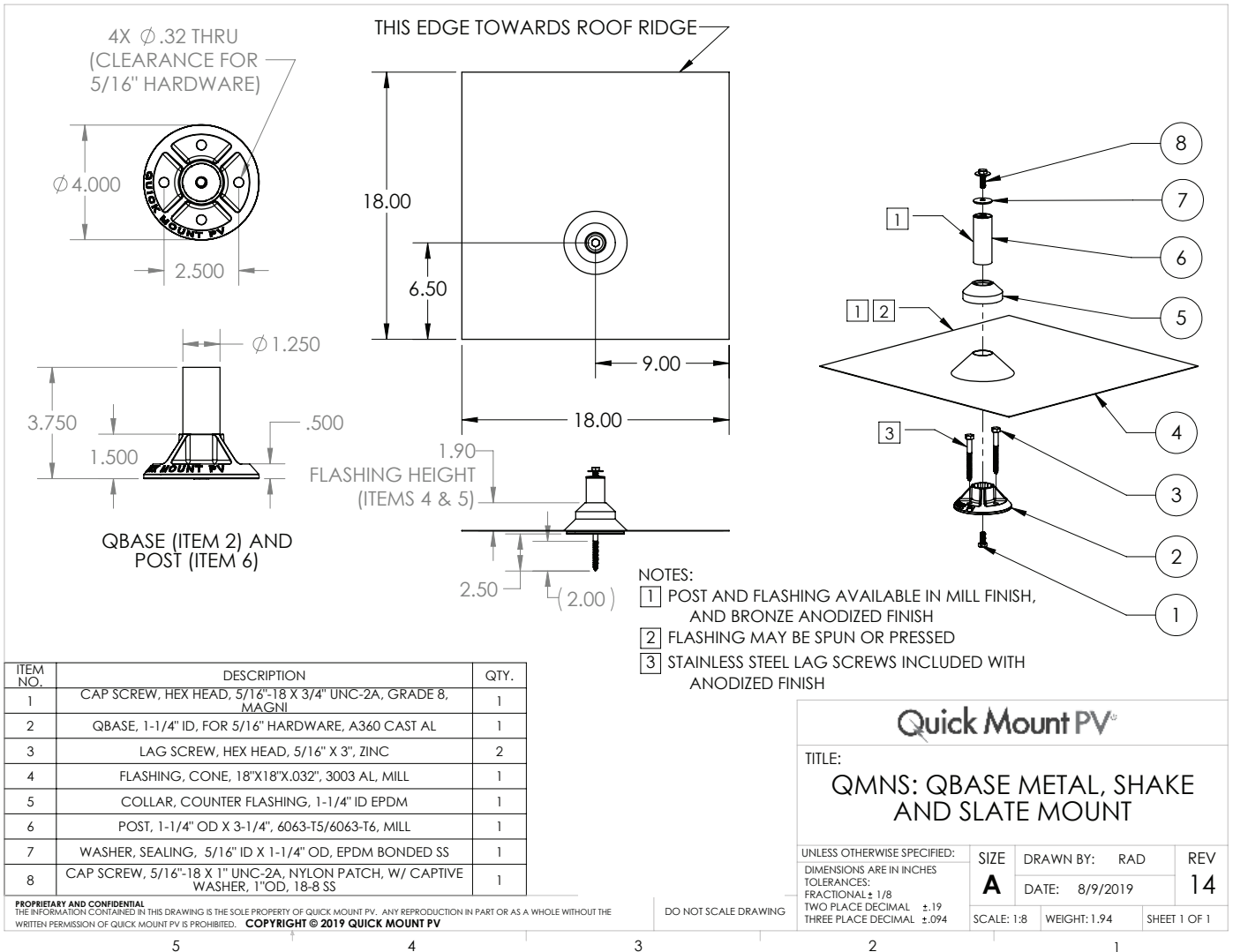

PLEASE NOTE: Cedar shakes treated with ACQ or CCA wood preservatives or fire retardant chemicals, or shakes with higher concentrations of natural tannins, may cause accelerated corrosion when in direct contact with aluminum. The Cedar Shingle & Shake Bureau recommends pre-painting both sides of the flashing using a good metal or bituminous paint. It is also advisable to use an appropriate physical barrier to isolate the aluminum from these corrosive chemicals. Accepted barriers include standard roofing felt, ice & water shield type underlayment, or 10 mil thick polyethylene sheeting. Please check with your shake roofer and/or supplier to see if your shakes require these barriers.

Caution: Prior to installation, check that proper screw embedment will be achieved for the necessary site load and roofing configurations.



# Installation Instructions for Shake Roof

**Installation Tools Required:** tape measure, roofing bar, chalk line, stud finder, caulking gun and sealant compatible with roofing material, drill with 7/32" bit, drill or impact gun with 1/2" socket

**WARNING:** Quick Mount PV products are NOT designed for and should NOT be used to anchor fall protection equipment.

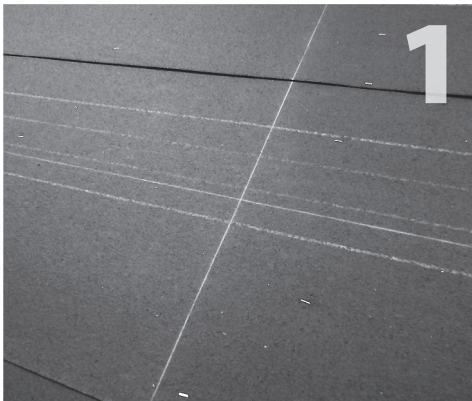

Lay out your array over the felt paper using a chalk line to mark rafter centers and the rail location centers.



Using the QBBase as a guide, mark pilot hole location for drilling. If roof is already felted, cut a section in the topmost layer for the QBBase, so that the shakes underneath can still slip under the felt.

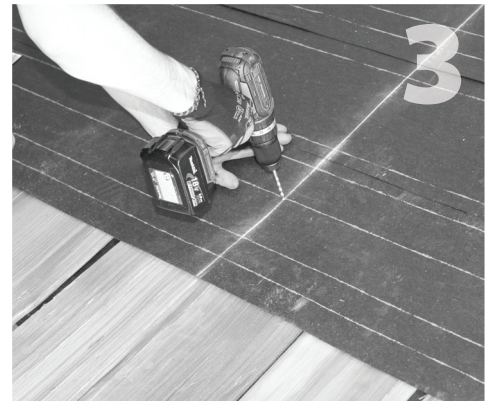

Drill 2 each 7/32" pilot holes into rafter. Do not use QBBase as a drill guide. Hold drill square to rafter. Fill pilot holes with sealant compatible with roofing material.

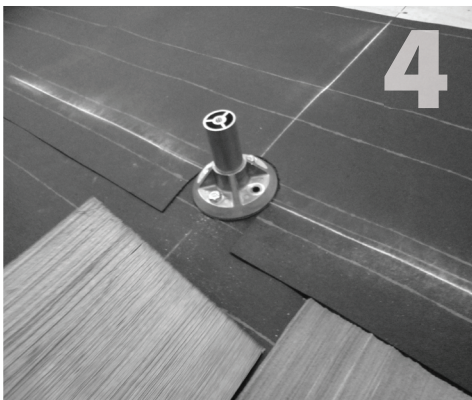

Prior to mounting to the roof, seat the grade-8 bolt (item 1) through bottom of QBBase, and screw post (item 6) into base. Place QBBase with post over drilled holes and secure lags (item 3) in place. Tighten to a snug fit.

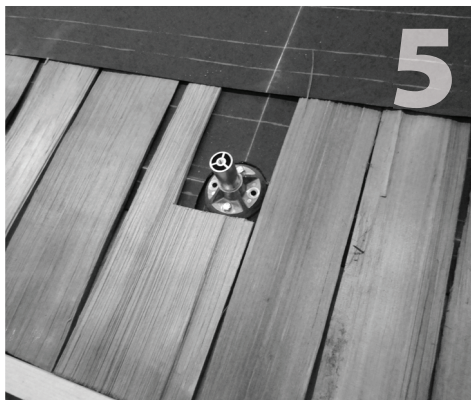

Roofing now continues. Cut shakes as needed to accommodate the QBBase.



Install the flashing at the point where the lower flashing edge is higher than the butt edge of the shake course directly under it, and the upper flashing edge reaches up under the same felt course as the shakes.



Apply a bead of sealant around the area where the cone flashing meets the post. Install the EPDM rubber counter flashing (item 5) over the post, and attach all the remaining hardware (items 7-10) on top of the post for safekeeping until the racking is ready to install.

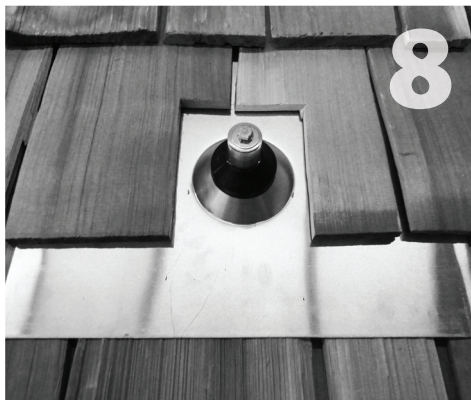

The mount installation is now complete. Continue roofing around the mount assembly, cutting shakes to accommodate the flashing cone.

You are now ready for the rack of your choice. Follow all the directions of the rack manufacturer as well as the module manufacturer.

All roofing manufacturers' written instructions must also be followed by anyone modifying a roof system. Please consult the roof manufacturer's specs and instructions prior to touching the roof.

# Installation Instructions for Slate Roof

**Installation Tools Required:** tape measure, slate roofing bar AKA slate ripper, chalk line, stud finder, caulking gun and sealant compatible with roofing material, drill, 4" diameter diamond embedded hole saw, masonry drill bit matching size of hole saw pilot drill bit, grinder with cutoff wheel, hammer, 7/32" high speed drill bit, and impact gun with 1/2" socket

**WARNING:** Quick Mount PV products are NOT designed for and should NOT be used to anchor fall protection equipment.



Mark the centerline of the rafter.

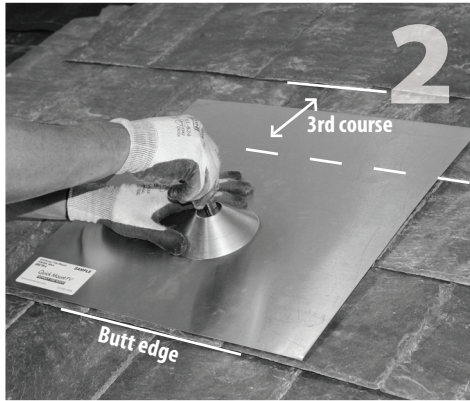

To mark the location of the QBase, position the bottom edge of the flashing flush with or just above the butt edge (drip) of the slate, the top edge extended up under the 3rd course, and the cone centered over your rafter centerline.



Using a masonry drill bit, drill a pilot hole at the center of the QBase location you marked in step 2. This drill bit should match the size of the guide bit of your hole saw.



Using a cutoff wheel in a grinder, score the slate above the mounting area at 4 inches above the center of the QBase location. In step 5, you will remove the slate below the score line, which will allow you to slide the flashing up under the remaining slate in step 10.



To remove the slate below the score, slightly lift the lower portion of slate with a slate ripper, then gently but firmly tap the top piece with a hammer. The lower piece should break off cleanly.



Using a 4" diameter diamond hole saw and the pilot hole drilled in step 3, drill through the existing slate.



Using QBase (item 2) as a guide, align two clearance holes vertically with the center of the rafter. Mark the center of these 2 holes. Drill 7/32" pilot hole at each of the 2 marks. Hold drill square to rafter. Do not use QBase as a drill guide.



Fill pilot holes with sealant compatible with roofing material such as Chemlink M-1, Geogreen 4500, or Solar Seal 900.



Prior to mounting to the roof, seat the grade-8 cap screw (item 1) through bottom of QBase. Secure the QBase to the rafter with (2) 5/16" lag screws (item 3) and tighten to a snug fit.

*continued on next page*

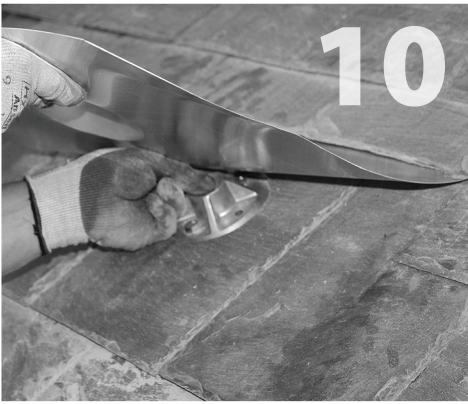

Slide the flashing over the QBase and under the slate above. Make sure you get up and under the 3rd course of slate.

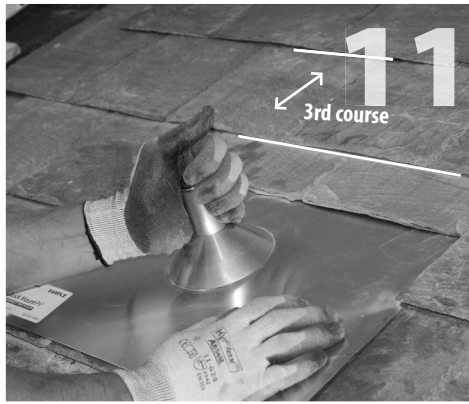

Screw on the post.



Apply a bead of sealant around the area where the cone flashing meets the post.



Install the EPDM rubber counter flashing over the post, and attach all the remaining hardware (items 7-10) on top of the post for safekeeping until the racking is ready to install.

You are now ready for the rack of your choice. Follow all the directions of the rack manufacturer as well as the module manufacturer.

All roofing manufacturers' written instructions must also be followed by anyone modifying a roof system. Please consult the roof manufacturer's specs and instructions prior to touching the roof.

## Additional Tips for Installing Mounts on a Slate Roof:

- If you have access to the underside of the roof, you can provide solid blocking at the location of the mount.
- It is possible that the roof is sheathed with solid wood boards that are thick enough to hold the mounts. It is important to verify the thickness, condition, and structural integrity of the wood you are attaching to and to consult an engineer licensed in your state to determine the bolting requirements.
- It can be difficult getting the flashing over the nails of the first course of slate. Helpful hint: slide the slate ripper up to or past the nail, then slide a piece of standard steel flashing over the slate ripper, allowing the slate ripper to guide the steel flashing over the nail. Then remove the slate ripper, slide the aluminum cone flashing into place and remove the steel flashing.
- Walking directly on a slate roof can break the slate. The most common way to distribute a person's weight is to lay a ladder on the slate roof and walk on the ladder. Be sure to secure the ladder so that it cannot slip or fall.

# Quick Mount PV<sup>®</sup>

925-478-8269 | [www.quickmountpv.com](http://www.quickmountpv.com) | [info@quickmountpv.com](mailto:info@quickmountpv.com)

2700 Mitchell Dr. | Walnut Creek, CA 94598